

RS *Tera*

Rigging Manual V3



PLEASE FOLLOW RIGGING MANUAL IN THE CORRECT ORDER



Contents

1. Introduction	1
2. Technical data	2
3. Commissioning	3
3.1 - Preparation	4
3.2 - Unpacking.....	4
3.3 - Pack contents	4
3.4 - Adding the toestraps	6
3.5 - Adding the toestrap elastic	7
3.6 - Adding the rope handles	8
3.7 - Adding the rear strop	9
3.8 - Adding the bung	9
3.9 - Adding the righting lines	10
3.10 - Adding the painter	10
3.11 - Rigging the mast	11
3.12 - Stepping the mast	12
3.13 - Rigging the boom	13
3.14 - Rudder and daggerboard	18
4. Sailing hints	20
4.1 - Introduction.....	22
4.2 - Launching	22
4.3 - Leaving the beach	22
4.4 - Sailing close hauled and tacking	23
4.5 - Sailing downwind and gybing	23
4.6 - Reefing	23
4.7 - Water bottle holder	25
5. Optional accessories	26
5.1 - Mini sail.....	27
5.2 - Fitting the rowing kit.....	27
5.3 - Fitting the performance downhaul	28
5.4 - Fitting the performance outhaul.....	31
5.5 - Top cover	35
6. Maintenance	36
6.1 - Boat care	37
6.2 - Foil care	38
6.3 - Spar care	38
6.4 - Sail care.....	38
6.5 - Fixtures and fittings	39
7. Warranty	40
8. Knots	41
9. Glossary	43

1. Introduction

Congratulations on the purchase of your new RS Tera and thank you for choosing an RS product. We are confident that you will have many hours of great sailing and racing in this truly excellent design.

The RS Tera is an exciting boat to sail and offers fantastic performance. This manual has been compiled to help you to gain the maximum enjoyment from your RS Tera, in a safe manner. It contains details of the craft, the equipment supplied or fitted, its systems, and information on its safe operation and maintenance. Please read this manual carefully and be sure that you understand its contents before using your RS Tera.

This manual will not instruct you in boating safety or seamanship. If this is your first boat, or if you are changing to a type of craft that you are not familiar with, for your own safety and comfort, please ensure that you have adequate experience before assuming command of the craft. If you are unsure, RS, your RS dealer, or your national sailing federation – for example, the Royal Yachting Association – will be able to advise you of a local sailing school, or a competent instructor.

RS Sailing highly recommends using RS supplied equipment for usage and storing of your craft. Deviation from using RS supplied equipment, such as sails and storage solutions, will require consultation with RS Sailing. Failure to do so may affect Warranty claims and Goodwill outcomes

Please keep this manual in a secure place and hand it over to the new owner if you sell the boat.

For further information, spares, and accessories, please contact:

RS Sailing
Premier Way
Abbey Park
Romsey
Hants SO51 9DQ
Tel.: +44(0)1794 526760
Fax: +44(0)1794 278418
E-mail: www.info@rssailing.com

For details on your local RS dealer, please visit www.rssailing.com

2. **RS** *Tera* Technical Data

Length Overall (LOA)	2.87m
Beam	1.23 m
Hull Weight	40 kg
Sailing Weight	56 kg
RS Tera Sport Mainsail	3.7 m ²
RS Tera Pro Mainsail	4.8 m ²
RS Tera Mini Sail	2.7 m ²
Draught	0.75m
Max Weight of Sailor	80 kg
Designer	Paul Handley

RS
Tera

3. Comissioning

RS
Tera

RS Tera 3.1 - Preparation

Your RS Tera comes complete with all the components necessary to take the boat sailing.







DO NOT use a knife or other sharp object to cut through packaging containing parts – you may damage the contents!



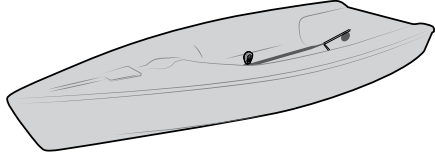







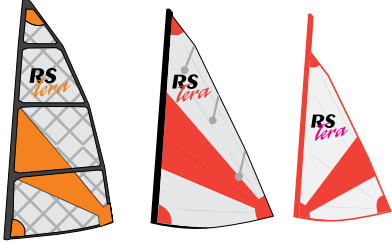

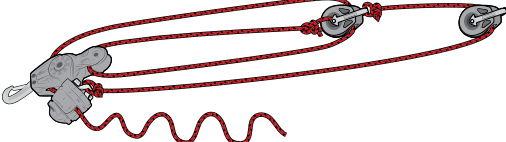

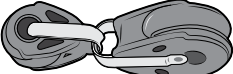

Whilst your RS Tera has been carefully prepared, it is important that new owners should check that shackles and knots are tight. This is especially important when the boat is new, as travelling can loosen seemingly tight fittings and knots. It is also important to check such items prior to sailing regularly

RS Tera 3.2 - Unpacking

Having unpacked your RS Tera, you should check that you have all of the items listed before throwing away any of the packing, as there may be some small items still wrapped.

RS Tera 3.3 - Pack Contents

		Quantity
	hull	1
	daggerboard	1
	rudder	1
	tiller extension	1
	bottom mast section	1
	top mast section	1

	<p>mainsail</p>	<p>1</p>
	<p>battens</p>	<p>3</p>
	<p>downhaul</p>	<p>1</p>
	<p>kicker</p>	<p>1</p>
	<p>kicking strap boom tie</p>	<p>1</p>
	<p>kicking strap mast tie</p>	<p>1</p>
	<p>mainsheet</p>	<p>1</p>
	<p>mainsheet traveller block</p>	<p>1</p>
	<p>Painter</p>	<p>1</p>
	<p>boom pad</p>	<p>1</p>
	<p>rope handles and plastic tubes</p>	<p>2</p>
	<p>plastic bobble</p>	<p>6</p>
	<p>mainsheet rear stop</p>	<p>1</p>
	<p>mast stump</p>	<p>1</p>
	<p>toestrap</p>	<p>1</p>
	<p>plastic hook</p>	<p>1</p>
	<p>toestrap elastic</p>	<p>1</p>
	<p>bung and rope tie</p>	<p>1</p>

RS
Tera 3.4 - Adding the Toestraps

a) Locate the toestraps in the customer pack.

FWD AFT



The diagram shows a long, narrow strap with a hook at one end. The word 'FWD' is printed on the left side and 'AFT' is printed on the right side.

b) Remove one screw the front toetraps fitting. This will allow you to rotate the fitting 90°.

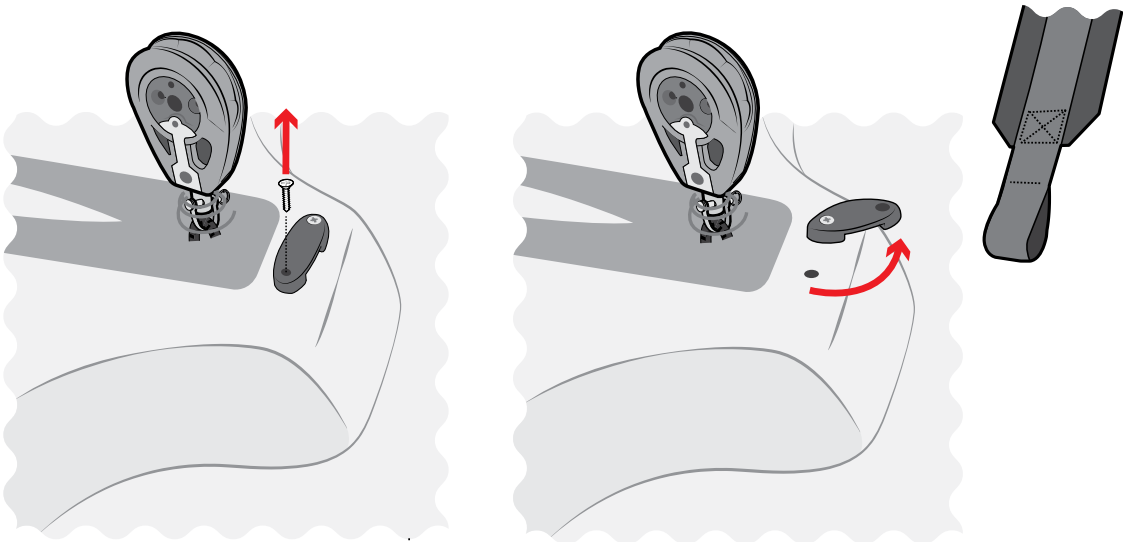

The first diagram shows a screw being removed from a fitting on a boat's hull. A red arrow points upwards from the screw. The second diagram shows the fitting being rotated 90 degrees clockwise, indicated by a red curved arrow. A toetraps strap is shown to the right.

c) Slide the webbing loop at the front end of the toetraps over the fitting, rotate it back into place and replace the screw.

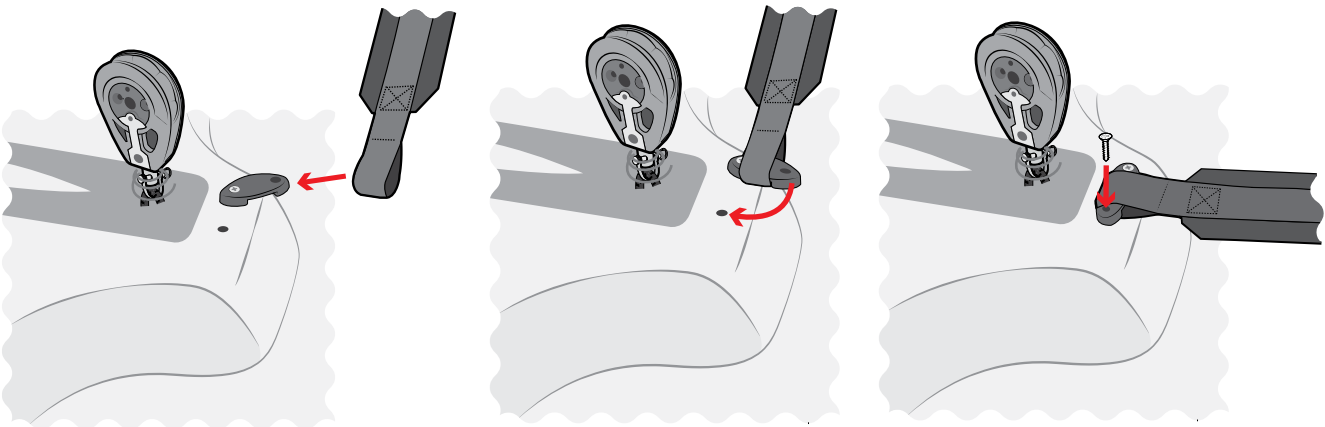

The first diagram shows the toetraps strap being moved towards the fitting. The second diagram shows the strap being rotated around the fitting, indicated by a red curved arrow. The third diagram shows the strap fully attached to the fitting, with a red arrow pointing to the screw being replaced.

RS *Tera* 3.4 - Adding the Toestraps

- a) Fit the webbing loop at the aft end of the to strap through the aft to strap fitting and back through the buckle as shown.

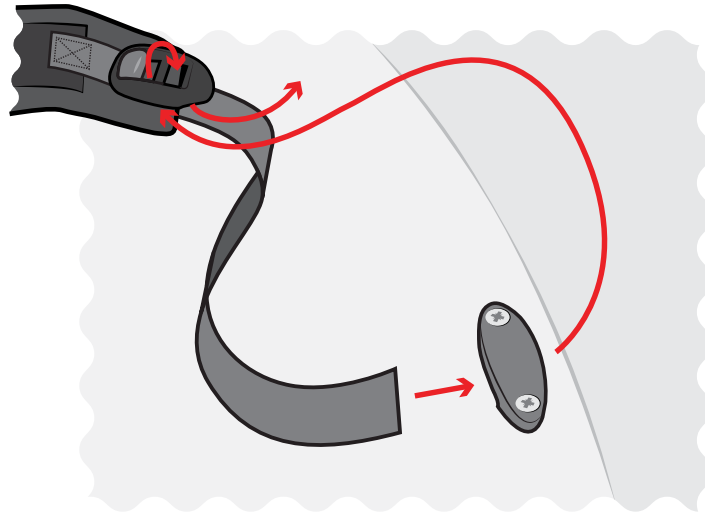

RS *Tera* 3.5 - Adding the Toe strap Elastic

- a) Add the toe strap elastic to the aft end of the toe strap as shown.

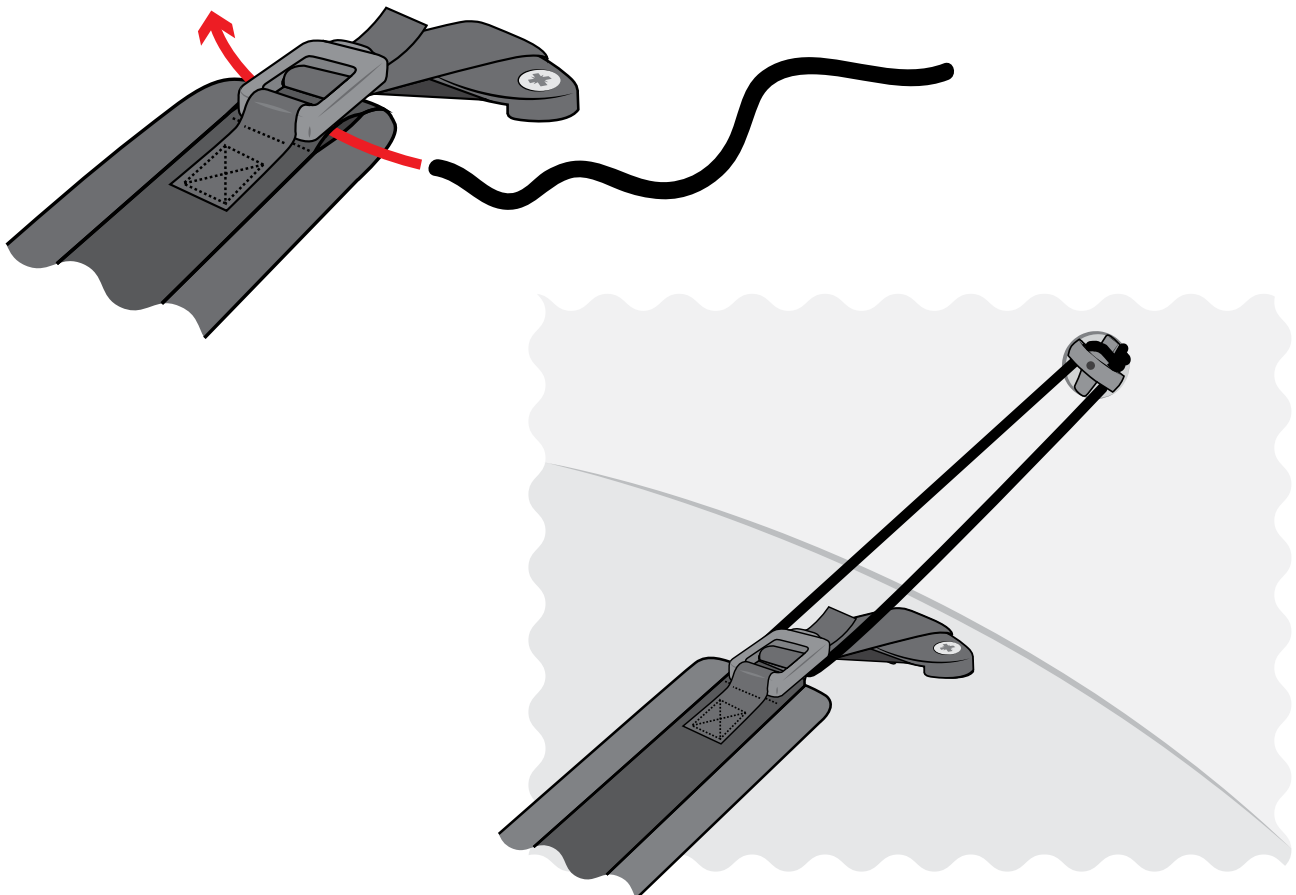

RS
Tera 3.6 - Adding the Rope Handles

- a) Locate the 2 x rear rope handles and 2 x plastic tubes in the customer pack.



- b) Thread the rope part through the plastic tubing.



- c) Pass both ends of the rope down through the holes in the gunwhale near the transom.

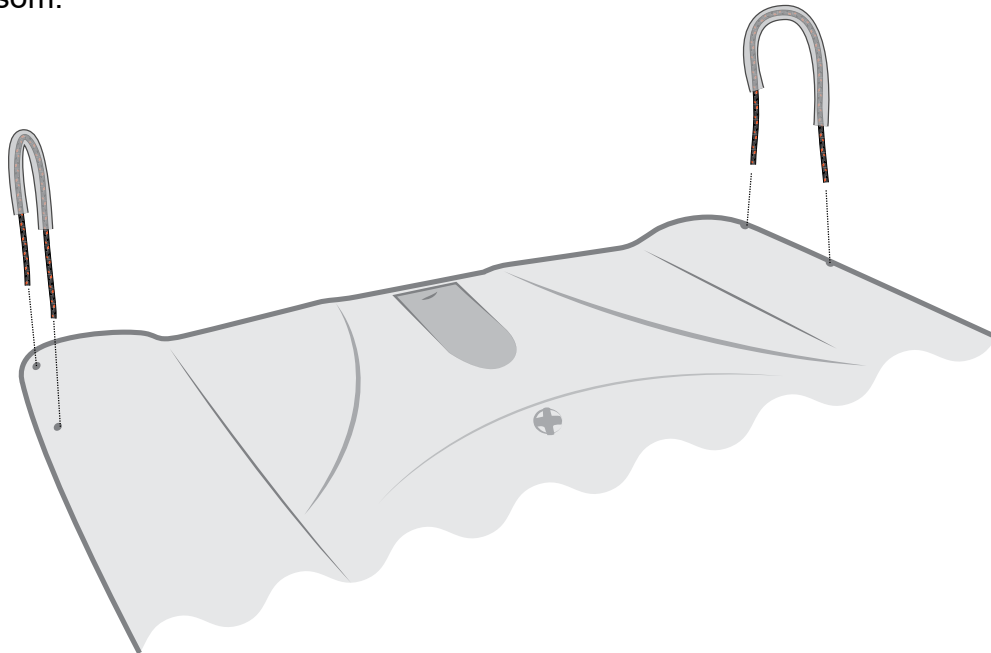

- c) Tie **knot #3** in the tails beneath the gunwhale.

RS
*Tera***3.7 - Adding the Rear Strop**

- a) Locate the x2 bobbles, rear strop and mainsheet traveller block in the customer pack.

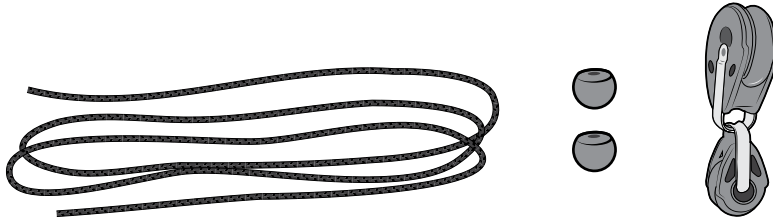

- b) Thread the rope through the smaller block, then pass the two ends down through the aft most holes in the transom (this shares a hole with the rope handles you added in **step 3.6**).

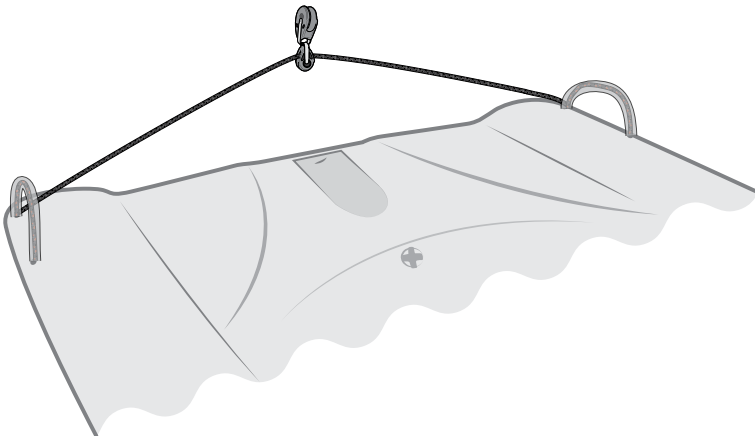

- c) Thread a bobble onto each end of the bridle and tie **knot #3** in the tails.

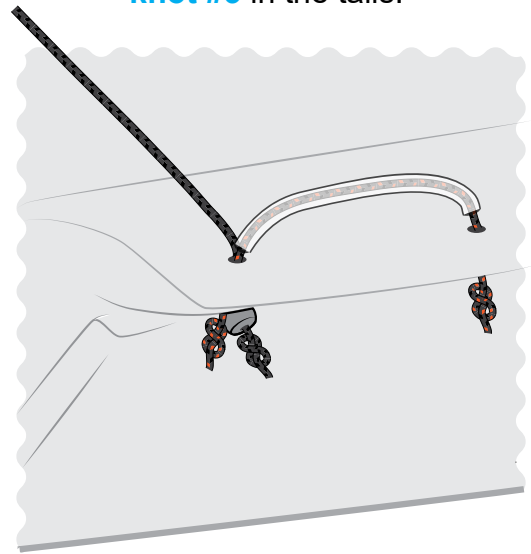
**RS**
*Tera***3.8 - Adding the Bung**

- a) Add the bung. The bung ties onto the cross shaped plastic fitting below the front end of the toestraps.

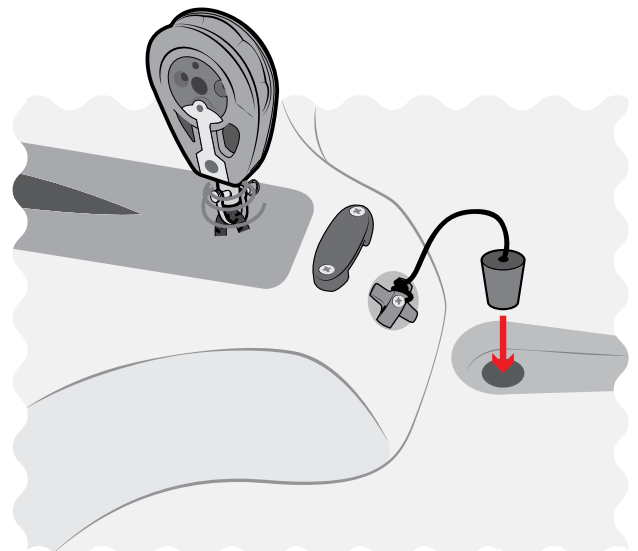

RS Tera 3.9 - Adding the Righting Lines

- a) Locate the 2 x righting lines and 4 x plastic bobbles in the customer pack.



- b) Pass the two ends of the righting line down through the holes in the gunwale, add a plastic bobble on each end and tie **knot #3** in the tail.

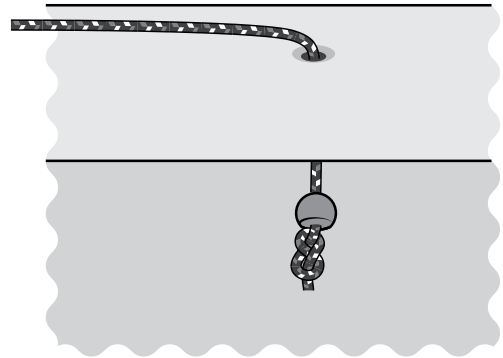
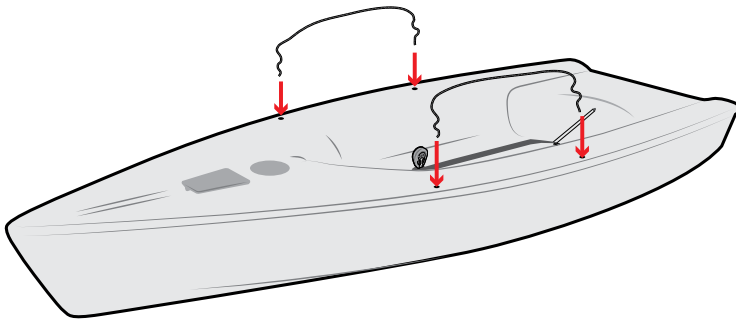

- b) Repeat on the other side of the boat.

RS Tera 3.10 - Adding the Painter

- a) Tie **knot #3** in one end of the painter, then thread the other end up through the hole in the bow from below.

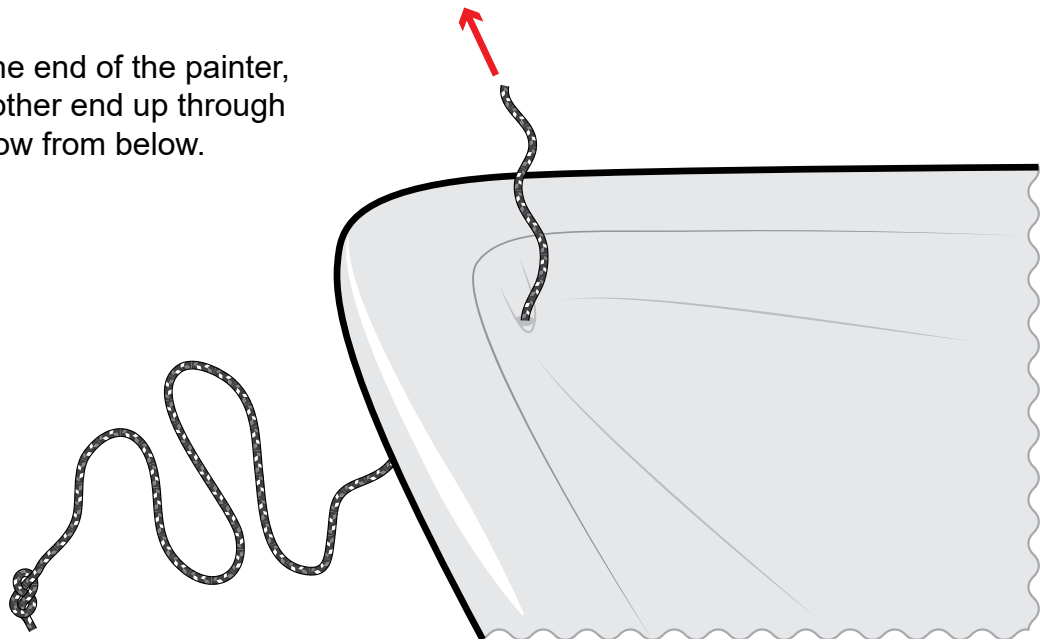

RS Tera 3.11 - Rigging the mast

a)

Add the mast stump to the foot of the mast.

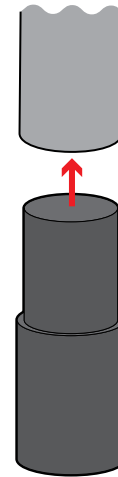

b)

Locate the mast top and bottom sections. There is a pin through the bottom section which sets the height of the mast. If you are sailing with a Pro mainsail, insert the pin in the upper hole of the mast bottom section. If you are sailing with a Sport mainsail, insert pin in the lower hole.

Pro mainsail

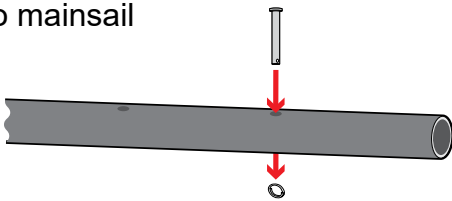

Sport mainsail

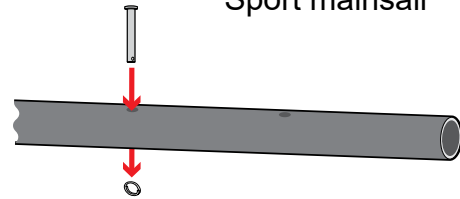

c)

Join the mast by inserting the mast top section into the mast lower section.

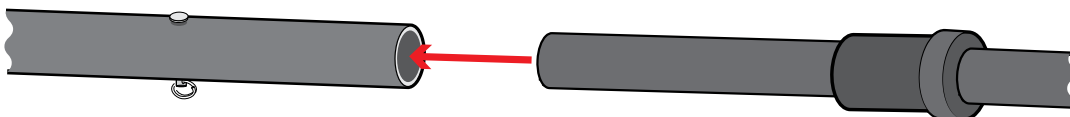

Push the mast top section in until it hits the pin.

d)

Slide the front sleeve of the sail over the mast until the mast top reaches the top of the sail.

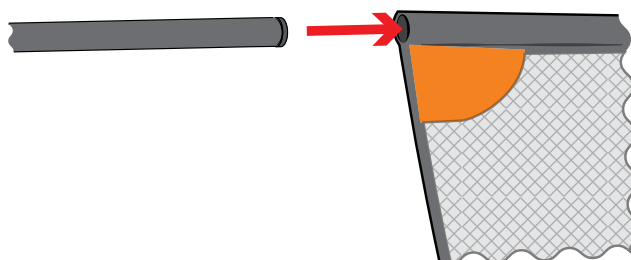

RS Tera 3.11 - Rigging the mast

e) Put the battens into the sail

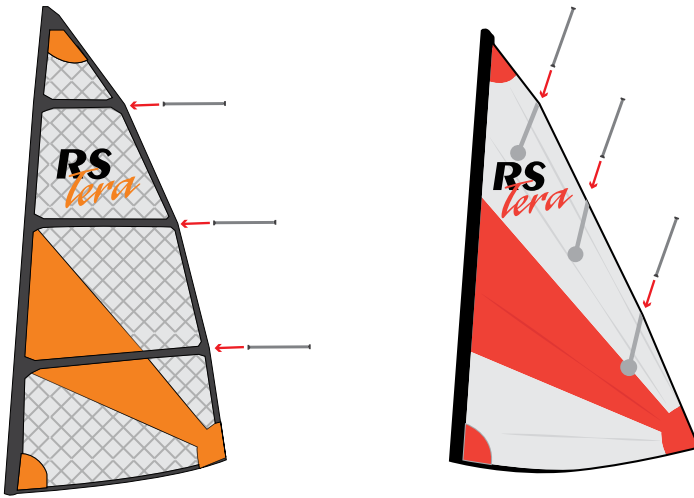

Battens are inserted with the curved end first, this engages against elastic in the pocket. Push the batten into the pocket until it goes under the flap on the leech. You will need to overcome the resistance of the elastic.

To remove, push against the elastic until the batten will come out of the flap then remove.

RS Tera 3.12 - Stepping the mast



BEFORE PICKING UP THE MAST, CHECK THAT YOU ARE NOT IN THE VICINITY OF OVERHEAD POWER CABLES



e) Lift the mast and sail over the mast plate on the deck.

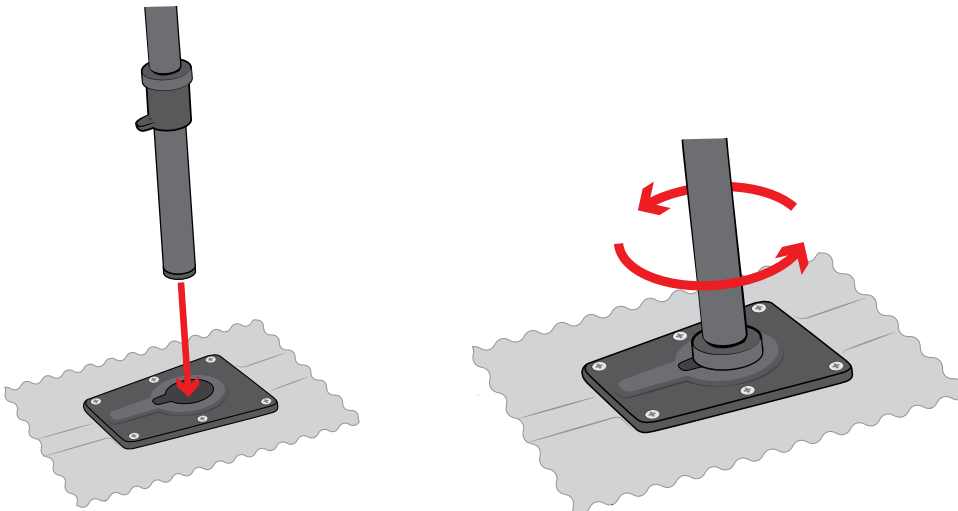

With the mast upright, lower the end through the mast plate ensuring that the retaining key is in line with the slot in the mast plate. When the mast is fully in, rotate it **through 180 degrees** so that the key is under the back of the plate.

Top Tip

If the wind is blowing there will be a lot of pressure on the top of the mast making it wave around. Consider finding somebody to help if you feel that you will struggle, especially with the Pro sail.

RS Tera 3.13 - Rigging the Boom

- a) Locate the 2 x 30mm vang blocks, vang bottom block and rope in the customer pack.
Assemble the vang as shown.

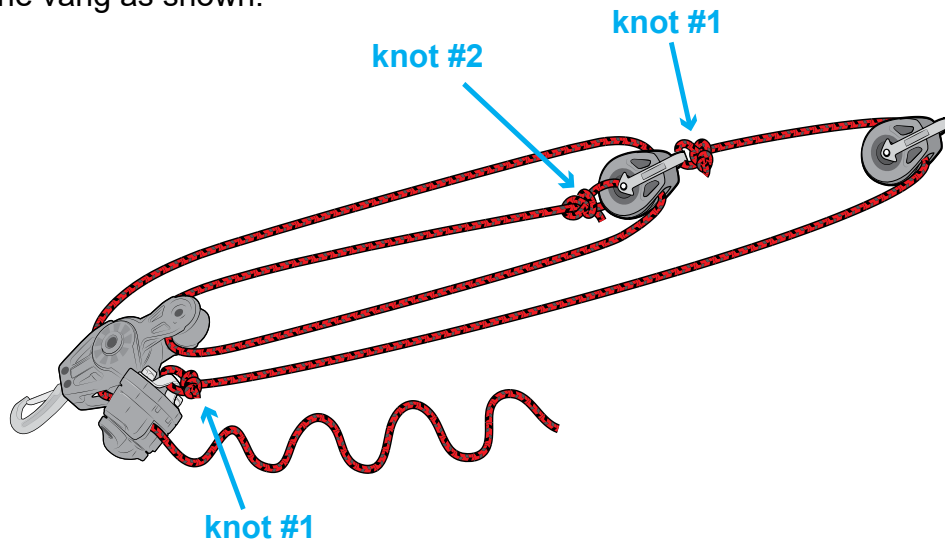

- b) Locate the top block on the kicking strap.

Tie the kicking-strap boom tie to the top block with **knot #1**.

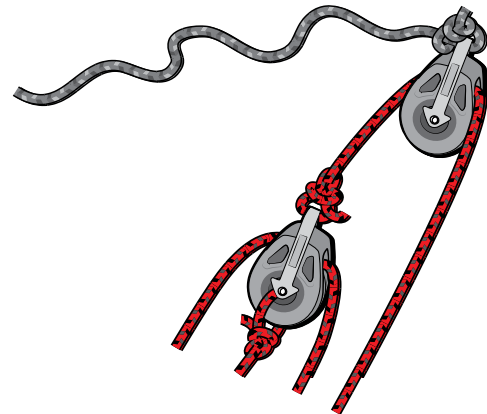
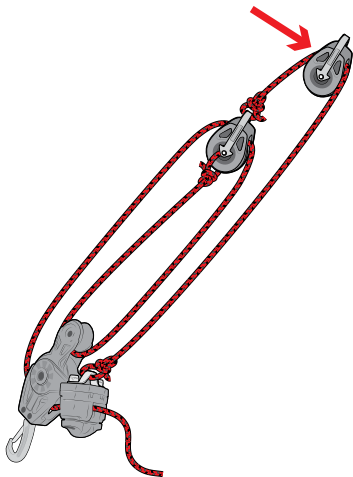

- c) Thread the kicking-strap boom tie through the eye on the boom, and tie **knot #3** in each end.

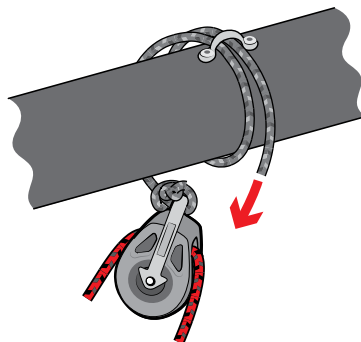

RS Tera 3.13 - Rigging the Boom

- c) Locate the kicking strap mast tie. Tie a figure of eight in one end.
- Thread it through the eye at the bottom of the mast, around the mast and back through the eye.
- Tie a figure of eight in the other end.

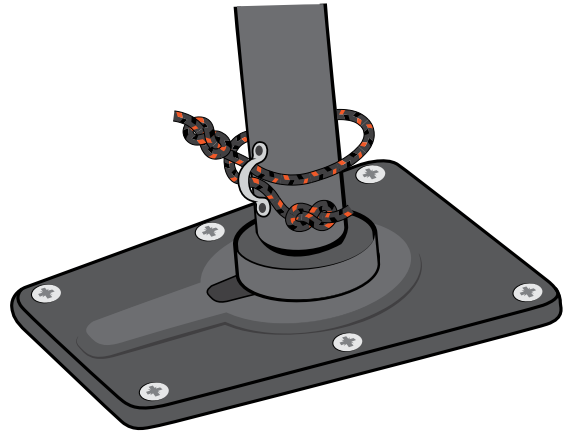

- d) Hook the kicking strap onto the rope loop you just added in **step c**.

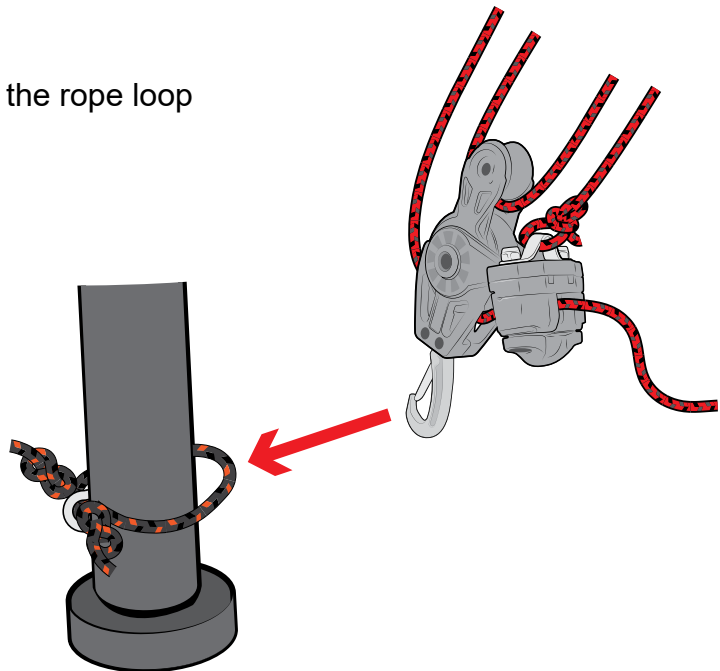

- e) Take the boom and push the gooseneck onto the mast, just above the plastic sleeve.

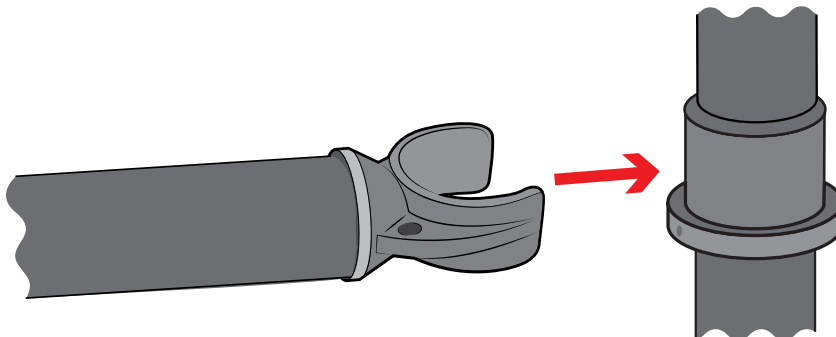

RS Tera 3.13 - Rigging the Boom

f) Attach the downhaul.

Pro Sail: Thread the downhaul through the hole in the mast collar, thread it through the sail eye, and back down to the cleat on the mast. Make sure that the downhaul runs on either side of the boom through the holes in the gooseneck.

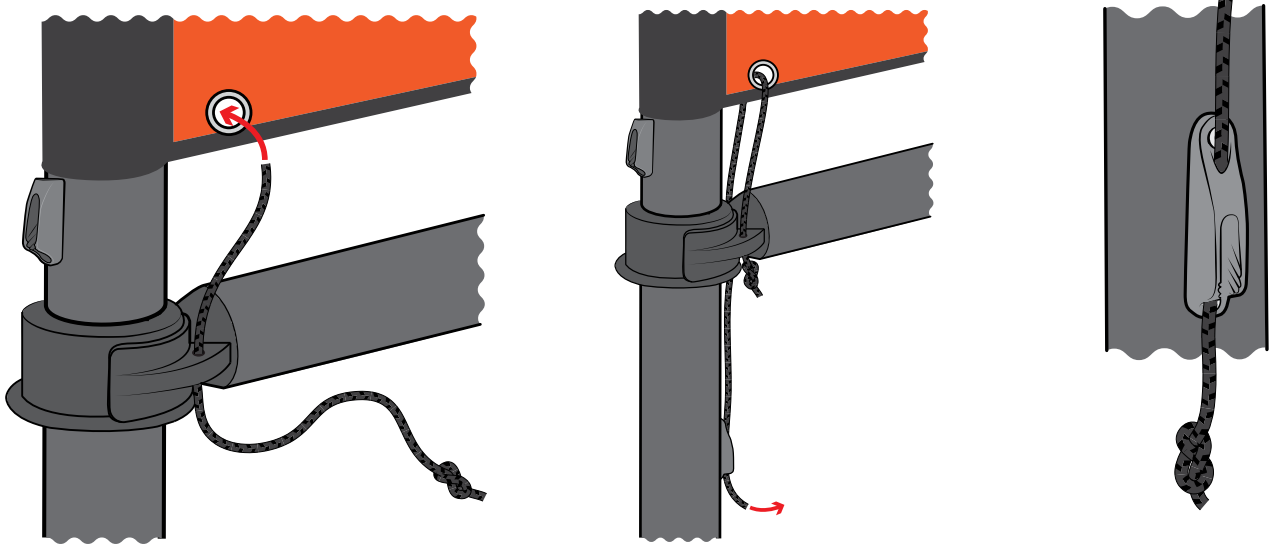

Sport Sail: Tie the downhaul on to the metal ring on the sail sleeve, then pass it through the cleat on the front of the mast. Coil and tie off the excess downhaul.

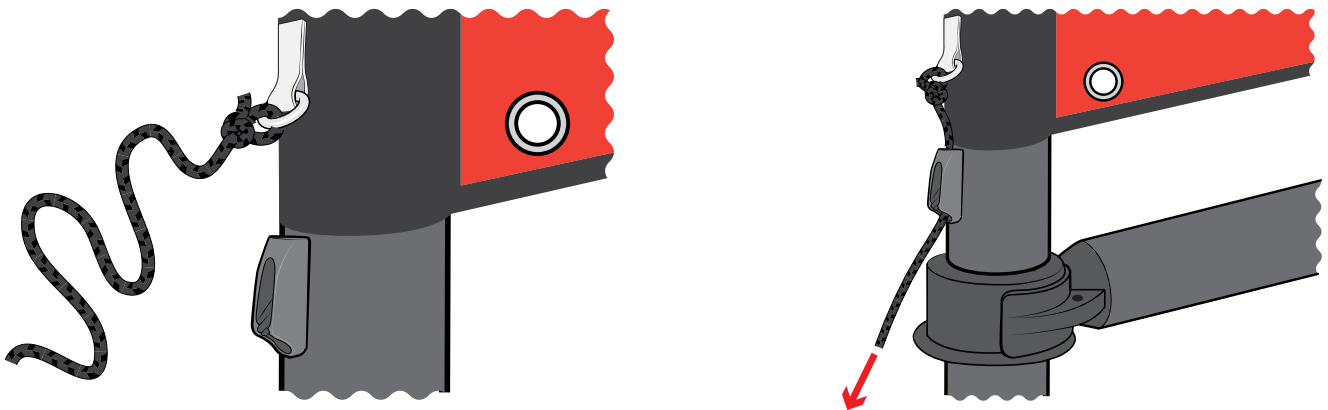

g) Attach the boom pad to the boom by joining the velcro edges.

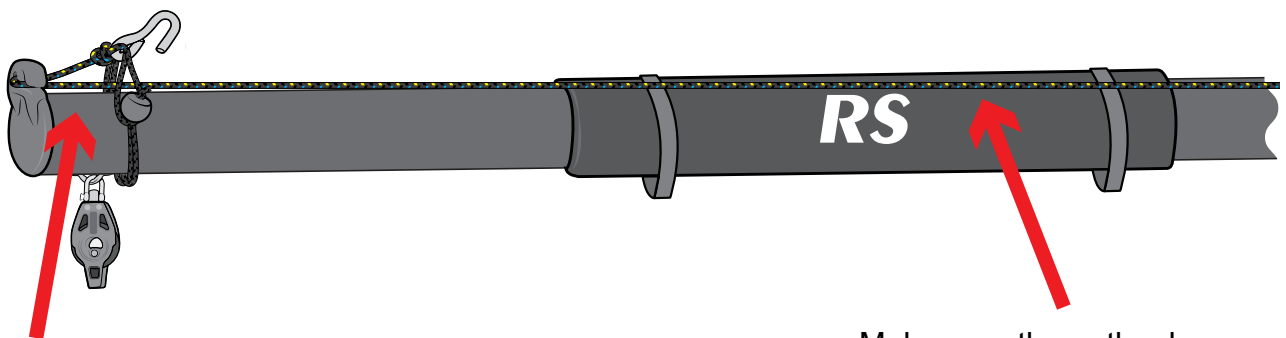

The outhaul comes already attached to the boom.

Make sure the outhaul passes outside the boom pad.

RS Tera 3.13 - Rigging the Boom

g)

Tie a stopper knot in the end of the mainsheet, and thread it through the becket on the block at the end of the boom.

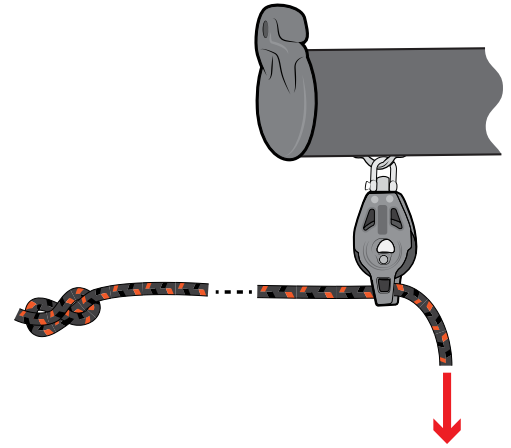

h)

Pass the end through the traveller block on the rear stop.



i)

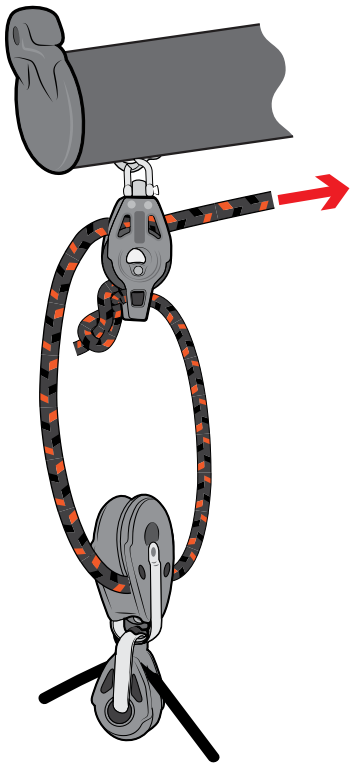

Thread the mainsheet through the block at the end of the boom in a forwards direction.

RS Tera 3.13 - Rigging the Boom

- k) Pass the tail of the mainsheet forwards along the boom, through the two webbing loops on the boom pad, and through the front block on the boom.

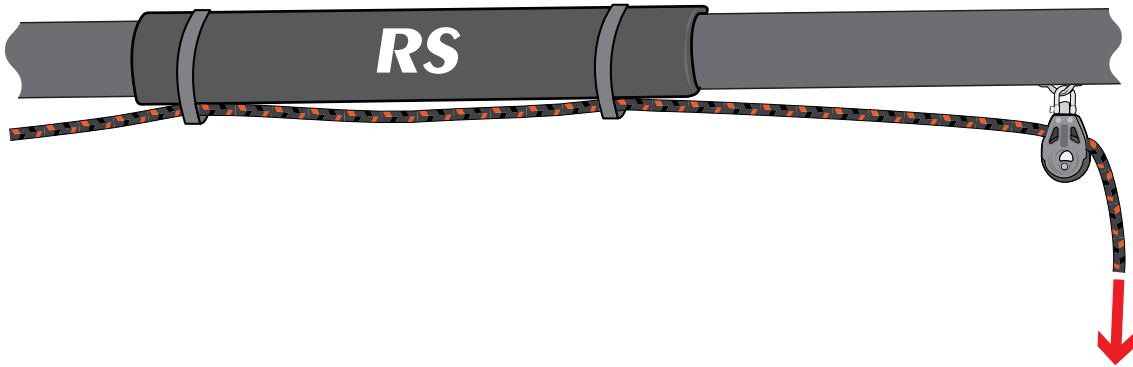

l)

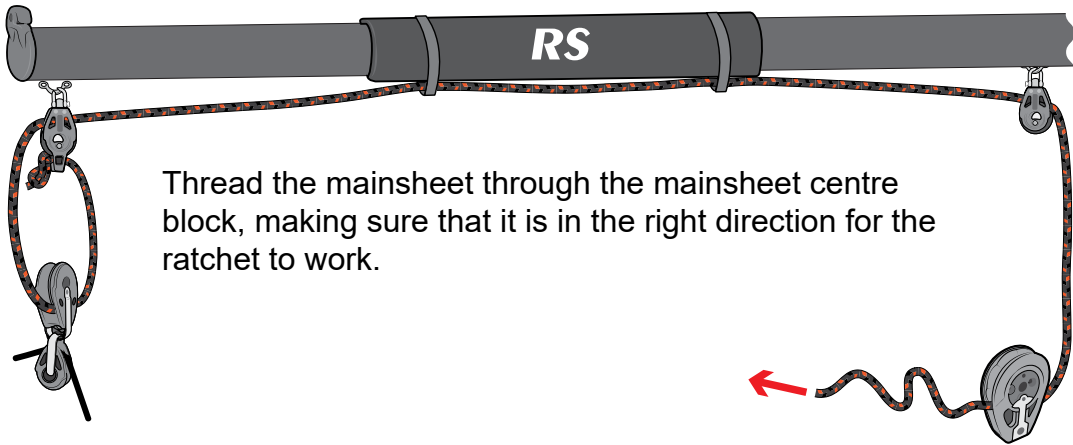

Thread the mainsheet through the mainsheet centre block, making sure that it is in the right direction for the ratchet to work.

Tie a knot in the mainsheet so that the boom cannot pass beyond a 90° angle to the hull centreline when you are sailing.

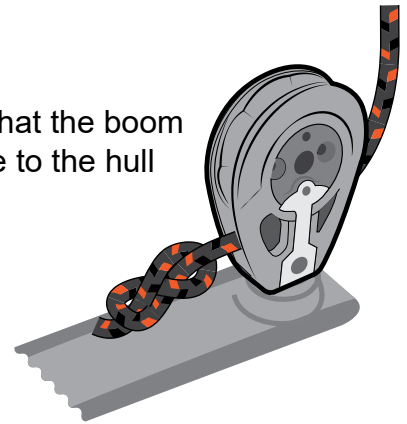

- l) Hook the outhaul onto the clew, pull tight and cleat.

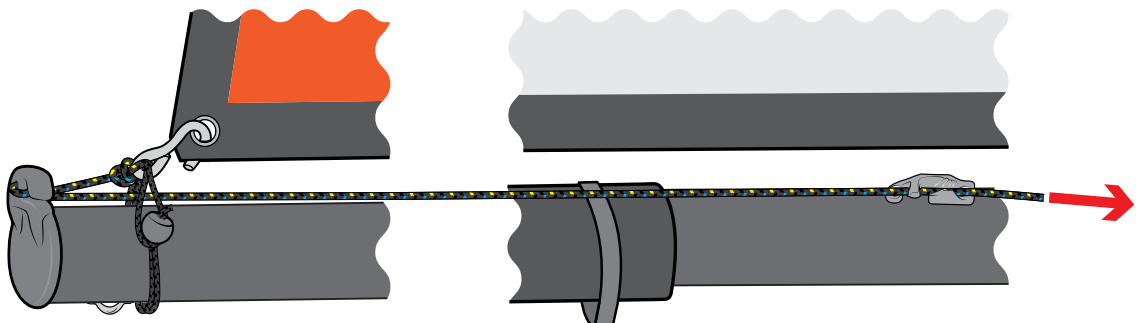

RS Tera 3.14 - Rudder and Daggerboard

a)

Slide the Tiller into the top of the rudder stock, and attach with the self-tapping screw. The screw is found taped into place on the rudder stock.

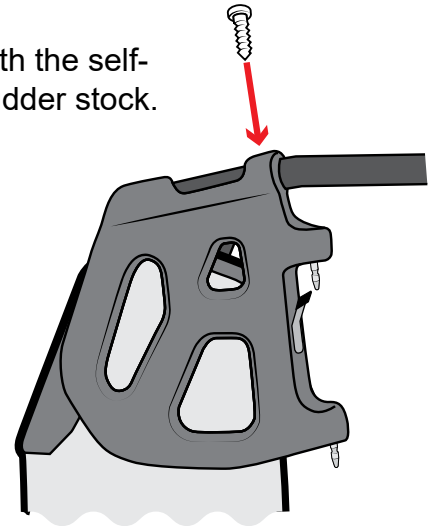
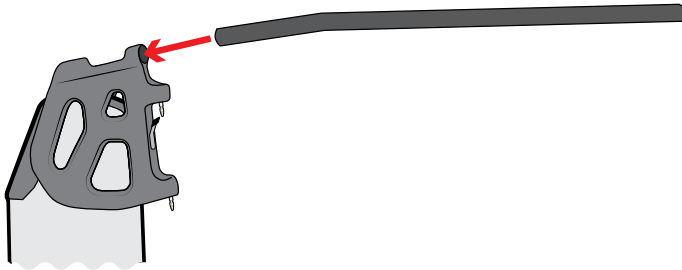

b)

Attach the tiller extension to the tiller by sliding it into the fitting and pushing down the cap.

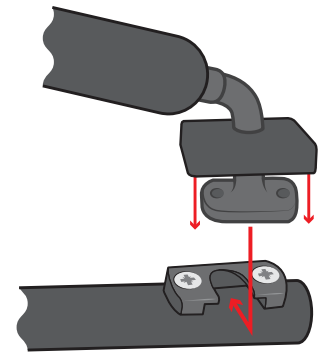

c)

Place the rudder on the transom with the rudder-uphaul line pulled tight, so that the rudder blade is fully up. Ensure that the tiller and the tiller extension pass under the mainsheet bridle. To fit the rudder, simply line up the pins with the fitting on the back of the boat, and push down until the retaining clip 'clicks' into place. The rudder may be difficult to get on at first – all it will need is a simple wiggle from side to side whilst pushing down.

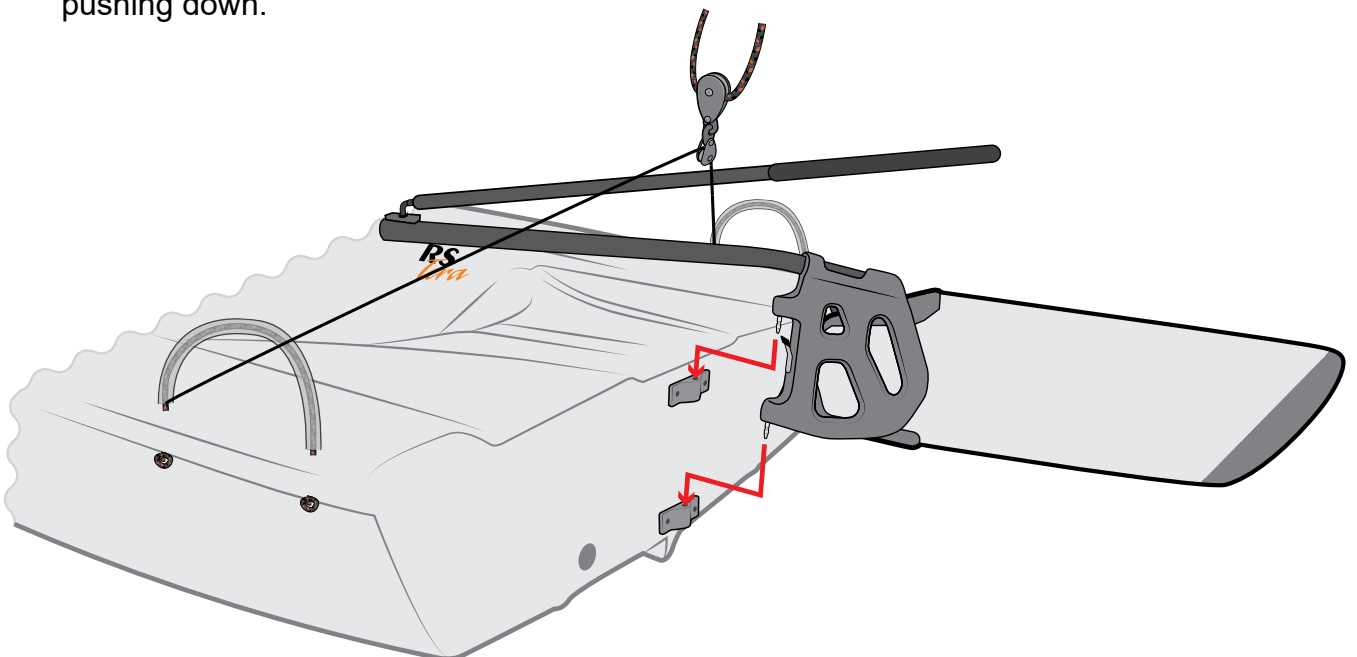

RS Tera 3.14 - Rudder and Daggerboard

d)

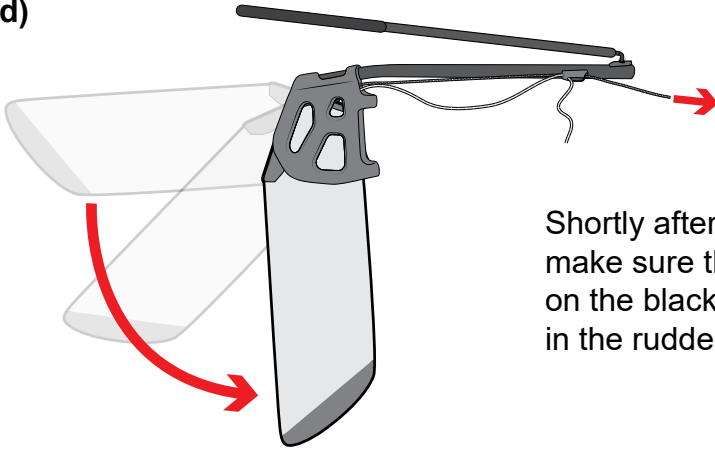

Shortly after launching, when you are in deep water, make sure that the white rope is not in the cleat, pull on the black rope, and cleat. This will lower the rudder in the rudder stock.

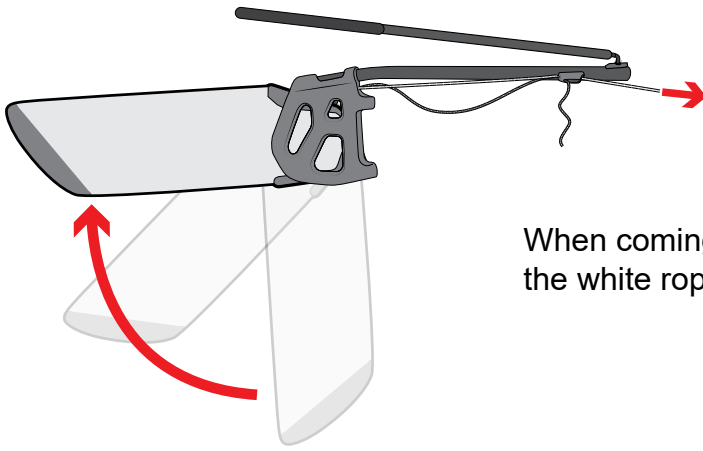

When coming ashore, unclat the black rope, and pull the white rope tight. This will raise the rudder.

e) To remove the rudder, simply push the rudder retaining clip in towards the rudder stock, and slide the rudder stock upwards.

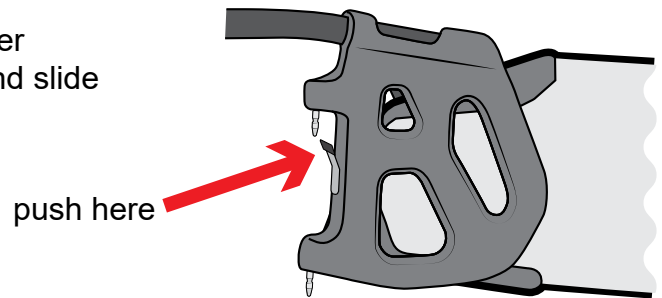

f)

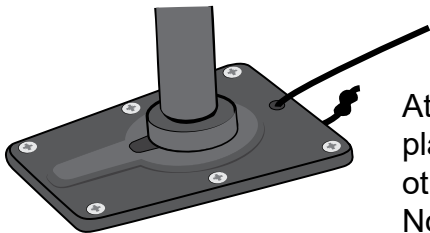

Attach the shock-cord retainer onto the plastic hook supplied using a bowline. The other end terminates at the mast step plate. Note warning sticker on the daggerboard.

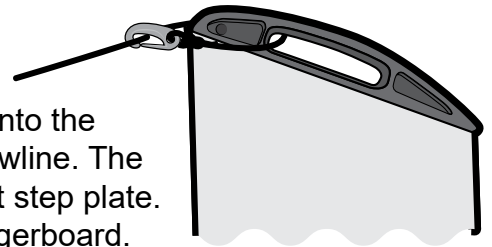

Please note comments in Section 6.2 regarding water ingress in foils

RS
Tera

4. Sailing Hints

RS
Tera

TIME TO GO SAILING!!

After launching, the rudder is lowered by releasing the uphaul line and pulling the elastic tight. The daggerboard can be inserted in the daggerboard case when the water is deep enough. It is normally best to leave the kicking strap loose while launching, pulling it on as appropriate once you are sailing.

TOP TIP

Make sure that you un-cleat the rudder and raise the daggerboard before coming in

RS *Tera* 4.1 - Introduction

The RS Tera is a very rewarding boat to sail – to fully appreciate its handling, you should be comfortable with the basic techniques of sailing small boats. If you lack confidence or feel that a refresher is in order, there are many approved sailing schools which use the RS Tera. See www.rya.org.uk for more information.

While we offer you a few hints to aid your enjoyment of your new boat, they should not be considered as a substitute for an approved course in dinghy sailing. In order to build your confidence and familiarise yourself with your new boat, we recommend that you choose a fairly quiet day with a steady wind for your first outing.

RS *Tera* 4.2 - Launching

With the sails fully hoisted and the rudder attached to the transom, the boat should be wheeled into the water, keeping it head to wind as far as possible. If you have a crew, s/he can hold the boat head to wind whilst the trolley is stowed ashore.

If the tide is coming in as you launch, make sure that you leave the trolley far enough up the beach that it will not be swept away.

RS *Tera* 4.3 - Leaving the Beach

You may wish to ask someone to help you to launch. If launching alone, stand in the water alongside the gunwhale, holding the boat head to wind. Lower part of the daggerboard and rudder, and then push the bow off the wind while hopping in.

As soon the water is deep enough, make sure that you lower the rudder blade fully by pulling the rudder downhaul hard. You will know it is fully down if you feel a gentle "thud" as the front face of the blade hits the front face of the stock. Cleat the downhaul and tidy it by winding it around the tiller. Pull the sail in and you are away!

For the best performance, you should ensure that position yourself so that the boat is sailing through the water as flat as possible. Watch the trim (fore and aft) and the heel. The boat should always be sailed as upright as possible.

Top Tip

As a general rule, sit further forward in lighter winds and further aft in stronger breezes.

RS Tera 4.4 - Sailing Close Hauled and Tacking

When sailing close-hauled, or as close as possible to the wind, it is important to get the boom as near as possible to the centreline. The kicking strap should be firmly tensioned for upwind work. To pull it on, quickly put the boat head to wind. You should hold the tiller extension across your body, with a knuckles- up grip, enabling you to use one or two fingers as a temporary cleat when adjusting the mainsheet.

To tack, push the tiller extension away from you and, as the boat starts to turn, step across the cockpit facing forwards. Once the boat has completed the turn, bring the tiller back into the centre before sitting down on the new side, with the tiller extension behind your back. When you are settled, swap the mainsheet and the tiller extension into the new hands.

If the boat slows right down and feels lifeless when close-hauled, you could be sailing too close to the wind. Ease the mainsheet and 'bear off' away from the wind for a while to get the boat going again.

RS Tera 4.5 - Sailing Downwind and Gybing

When sailing downwind, the sail should be let out until about 90 degrees to the centre line. To gybe, pull the tiller towards you and, as the boat starts to turn, step across the cockpit facing forward. Once the boat has completed the turn, bring the tiller back into the centre before sitting down on the new side, with the tiller extension behind your back. Often, the boom will not want to come across until you have nearly completed the gybe, so it often pays to give the mainsheet a tweak to encourage the boom over at the moment that you want it to come! Once you are settled, swap the mainsheet and the tiller extension into the new hands.

Mind your head when you gybe!

RS Tera 4.6 - Reefing - Only applicable to RS Tera Sport and Mini sail rigs

- a) Leaving the downhaul in the cleat, unclip the kicking strap from the eye at the bottom of the mast.

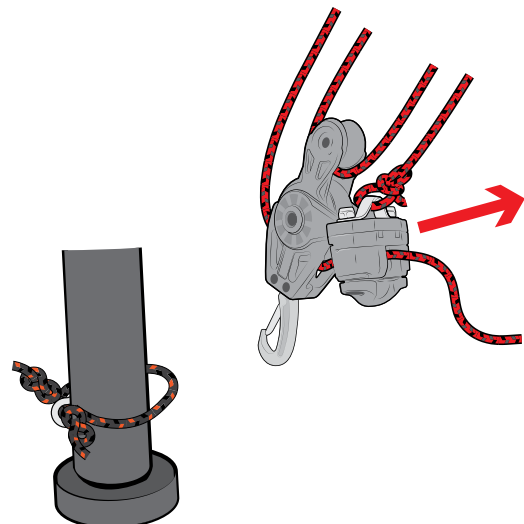

- b) Release the outhaul by removing it from the cleat on the boom, and pulling extra line through.

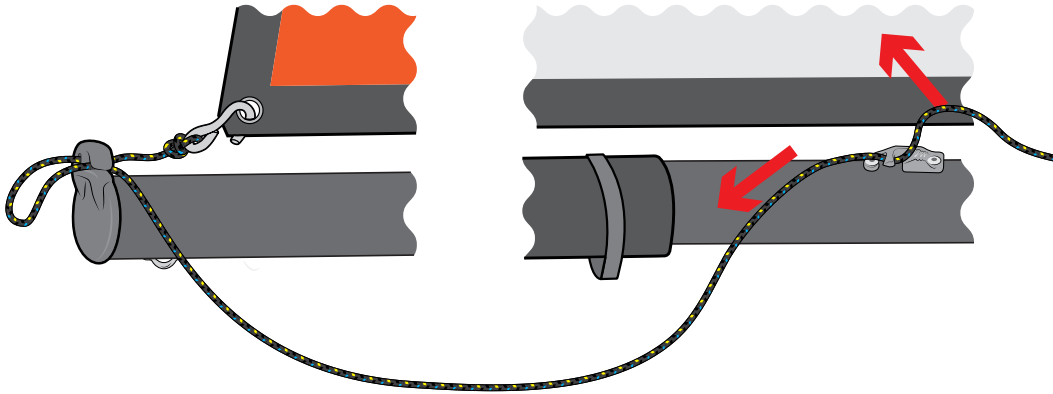

- c) Twist the mast so that the sail wraps around it, until you reach the appropriate size of sail.

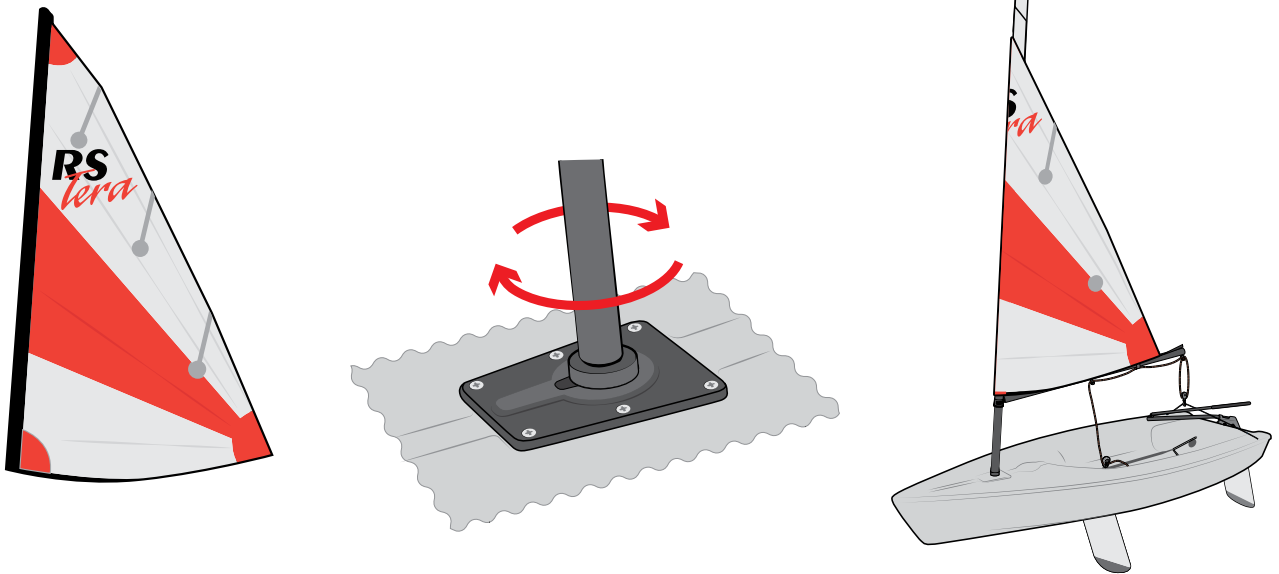

- d) Re-attach the kicking strap to the loop at the bottom of the mast and pull on the outhaul. You are now reefed and ready to sail!

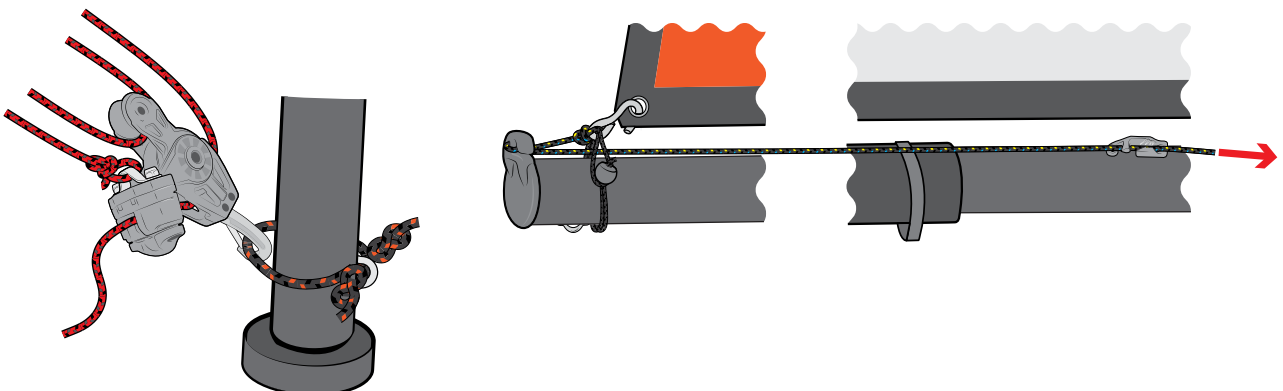

RS
tera 4.7 - Water bottle holder

In front of the dagger board is a recessed black plastic cross with a loop of black bungy attached. This is a water bottle holder.

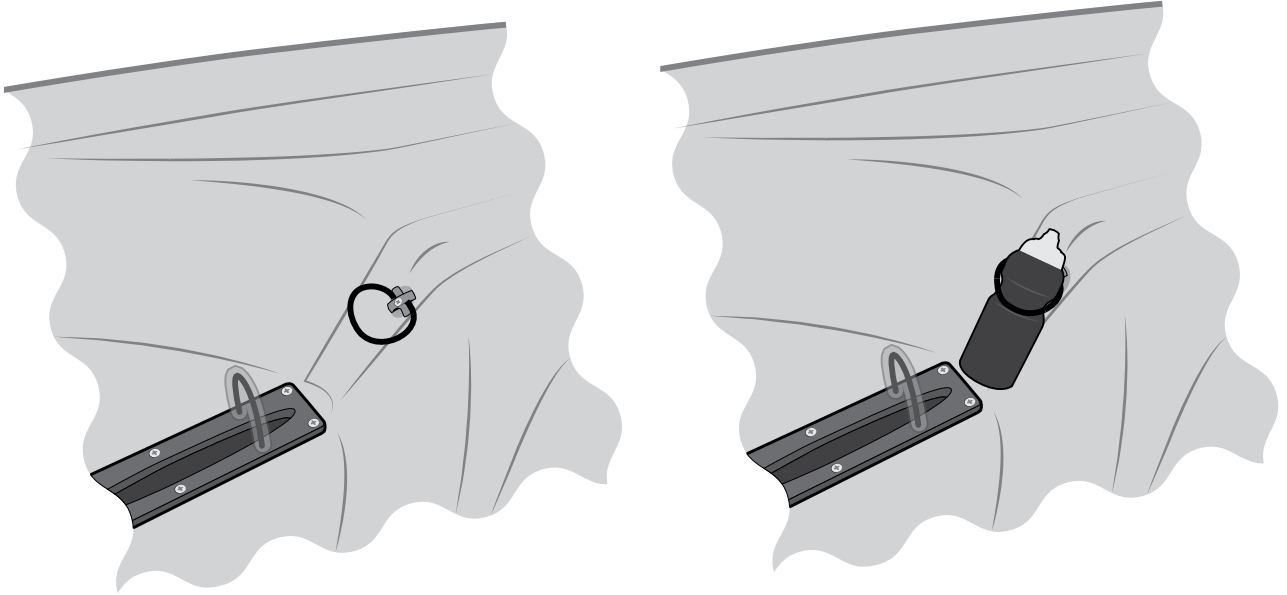

RS
Tera

5. Optional Accessories

RS
Tera

RS Tera 5.1 - Mini Sail

a)

The Mini Sail is perfect for lighter-weight crews or novices, and can be purchased as an additional extra. The Mini Sail differs in appearance to the Sport and the Pro, due to the Dacron sock at the top, but is rigged in exactly the same way as the other sails (see Section 3.4).



RS Tera 5.2 - Fitting the Rowing Kit

The RS Tera Rowing Kit may be purchased from RS Sailing or from your local RS Dealer, enabling you to use your sailing boat as a tender or small rowing vessel.

a)

Before using the oars for the first time you must fit the rowlock inserts into the recesses on the unwhales using the screws provided.

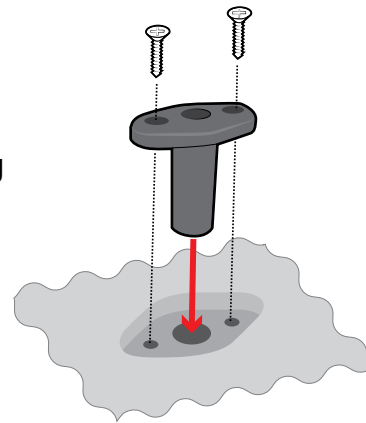

b)

To locate and lock the oars in position, push the spigot in the rowlock hole and rotate the complete oar, so that the paddle is over the cockpit and the handle is over the side of the boat.

As you turn the oar into the correct position, with the paddle over the side and the handle over the cockpit, you will feel the oar lock into place. The oar will not pull out. To release the oar, reverse the procedure.

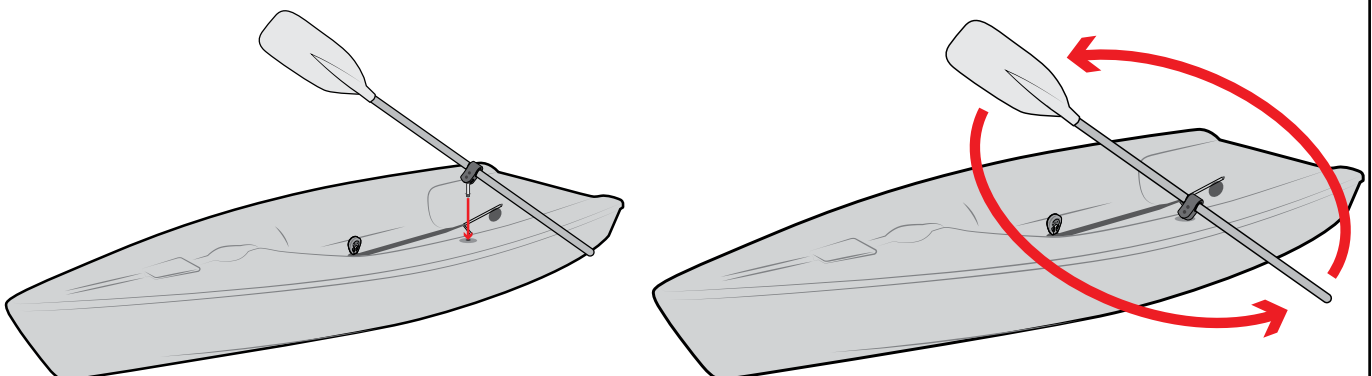

RS Tera 5.3 - Fitting the Performance Downhaul

Contents:

plastic bobble



block on d12 rope with loop

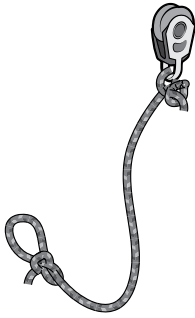

D12 rope with loop

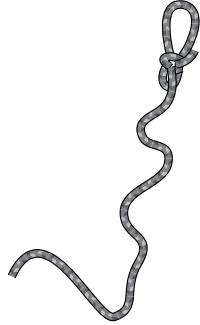

block on d12 rope with cow hitch



downhaul rope



a)

Take the D12 rope with the block cow hitched to it and tie it around the mast, through the bottom deck eye (the same one as the kicker mast tie).

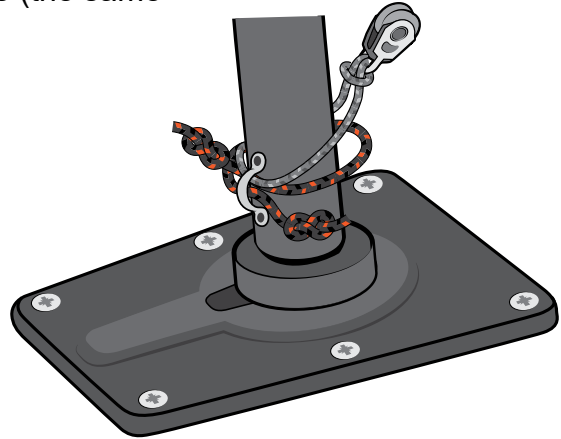
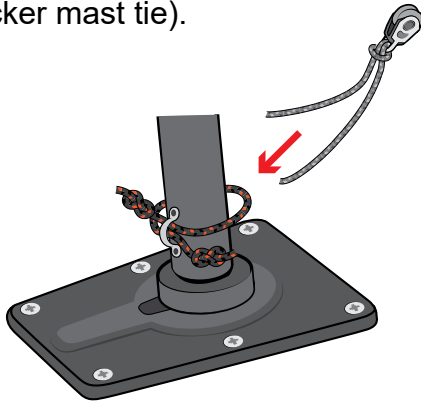

b)

Take the D12 rope with loop and pass the free end around the mast (just below the boom gooseneck joint) and then back through the loop

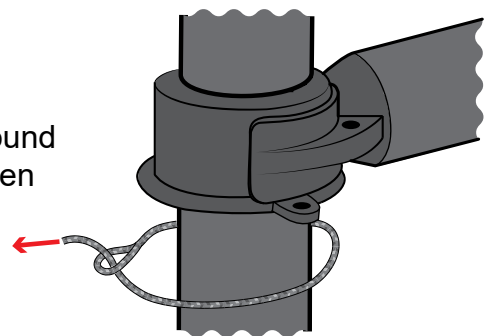

c)

Pass the tail of the D12 up through the hole in the gooseneck collar.

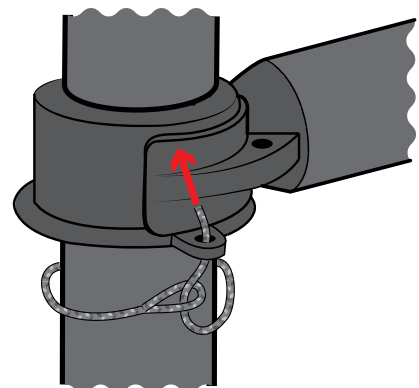

RS
tera 5.3 - Fitting the Performance Downhaul

- d) Slide the plastic bobble onto the D12 and tie a half hitch in the tail close to the gooseneck .

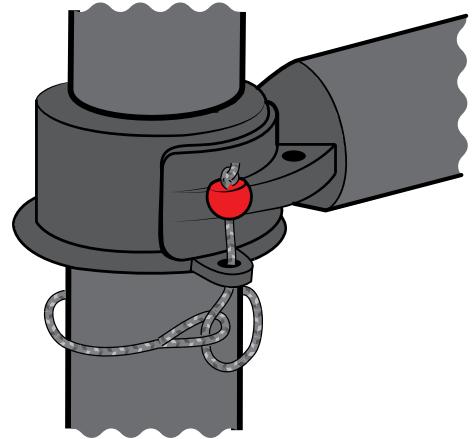

Cut off any excess tail and seal the end.

- e) Take the remaining block (on D12 rope with loop at the end).
Tie one end of the downhaul rope through the centre hole of the block.



- f)

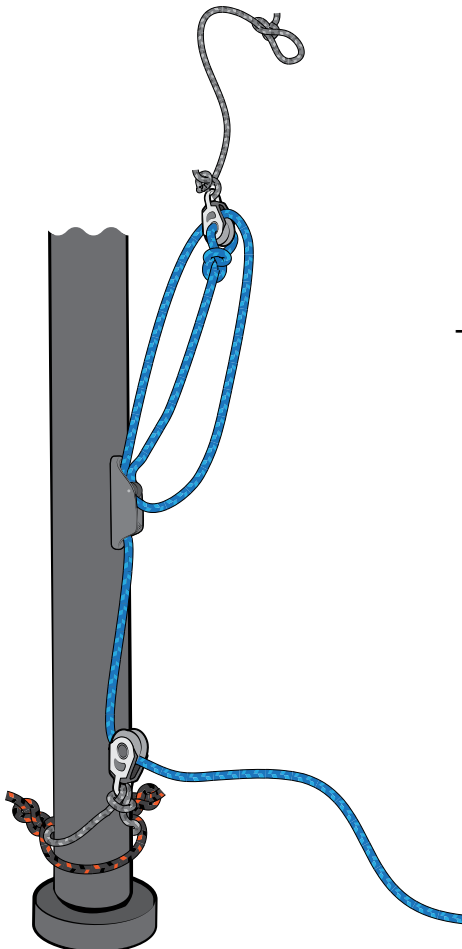

Thread up the purchase as shown.

RS
Tera 5.3 - Fitting the Performance Downhaul

g)

Pass the loop on the end of the D12 up through the cringle on the sail.

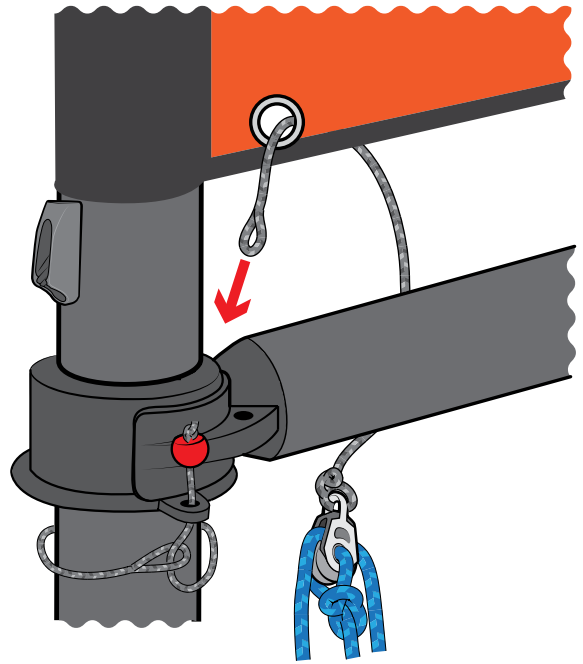

h)

Hook the rope loop over the plastic bobble.

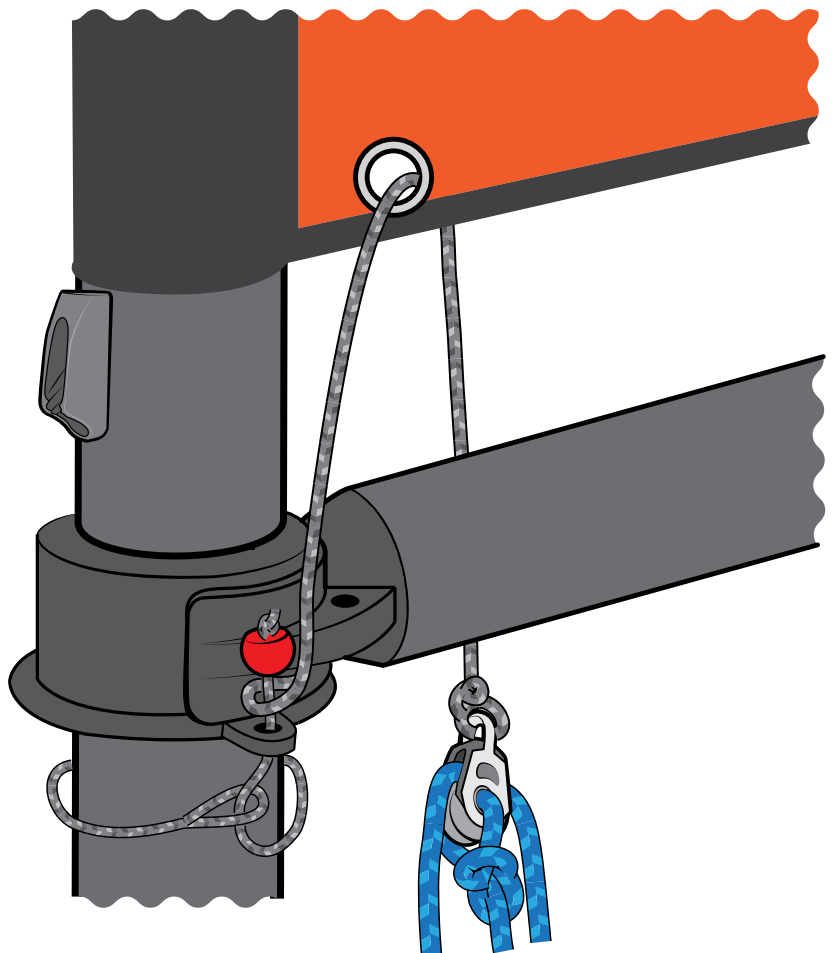

The performance downhaul is now ready to use.

RS Tera 5.4 - Fitting the Performance Outhaul

Contents:

20mm block cowhitched to D12 (x2)

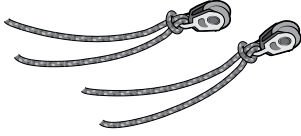

20mm block



2.06m x 4mm rope



a)

Remove the old outhaul line. Leave the metal clew hook strapped to the boom.

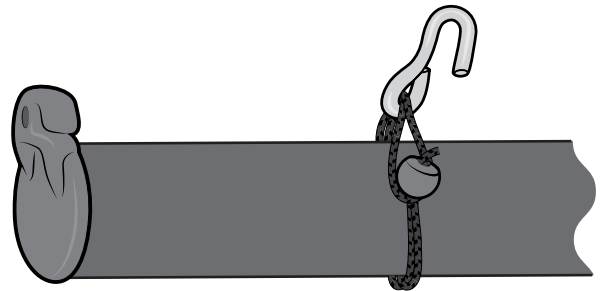

b) Take one of the blocks cowhitched to a piece of D12.

Pass the two ends of the D12 aft through the holes in the port side of the boom end cap and tie a stopper knot in each end close to the end cap.

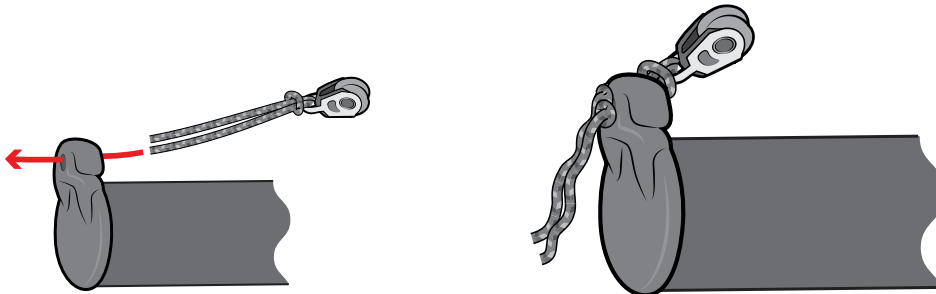

c) Take the old outhaul rope and pass one end through the starboard hole in the boom end cap and tie a stopper knot.

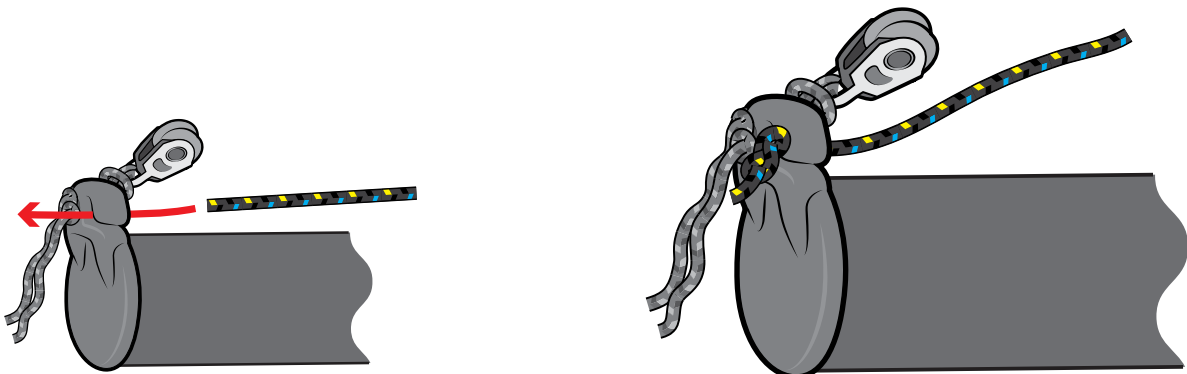

RS Tera 5.4 - Fitting the Performance Outhaul

d)

Pass the free end of the old outboard line through the base of the metal clew hook.

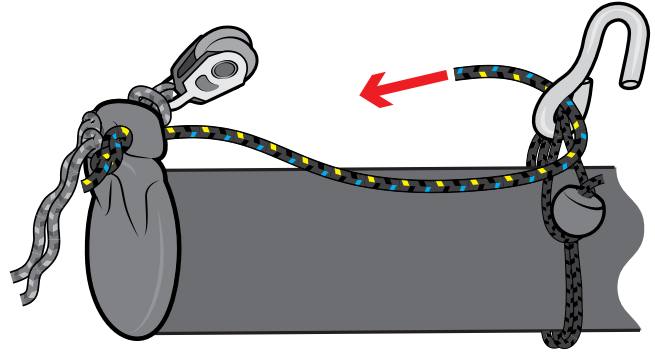

e)

Pass the end of the old outhaul rope through the block added in **step b**.

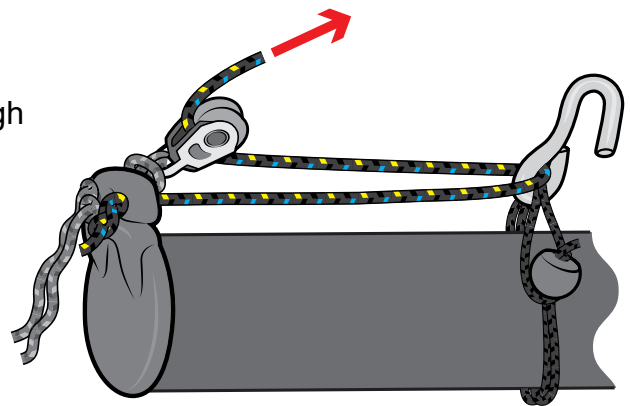

f) Take this line forward along the boom towards the cleat and attach a 20mm block approximately 1.1m in from the end of the rope using a knot on knot. This excess tail will be cut off and the ends sealed, but not yet.

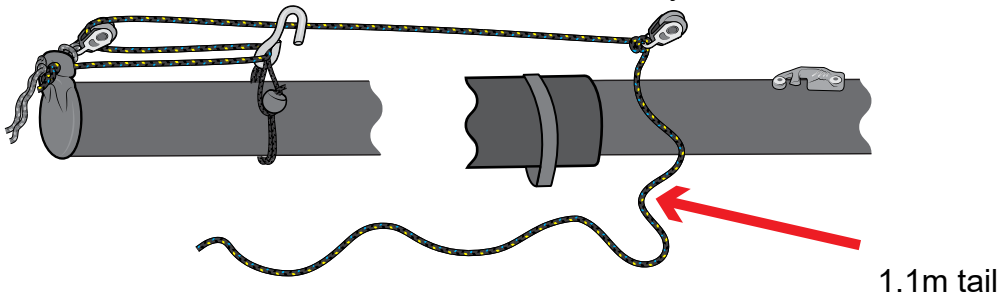

f) Take the rope loop with bobble from the original outhaul. Pass the loop through the base of the metal hook, around the boom and over the bobble to attach the hook to the boom.

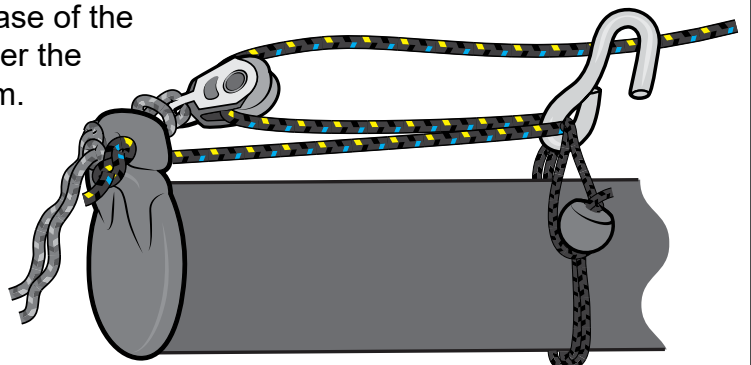

RS Tera 5.4 - Fitting the Performance Outhaul

g)

Take the other block cow hitched to D12 from the pack.

Tie this block onto the plastic deck eye at the inboard end of the boom using a reef knot.

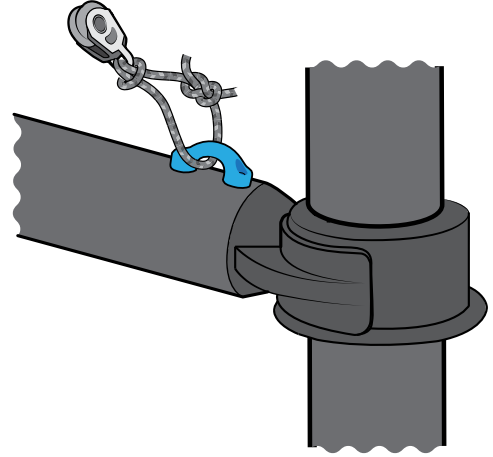

h)

Take the 2.06m x 4mm rope from the pack and tie one end onto the boom cleat with a knot on knot.

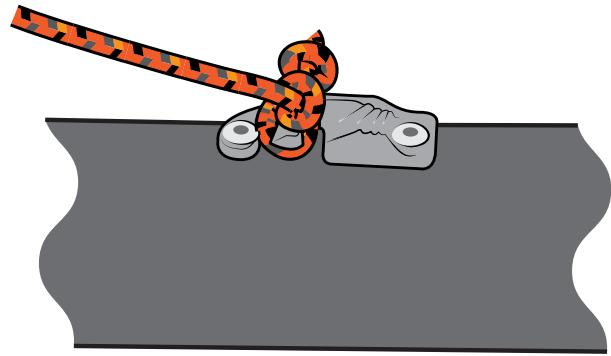

i)

Thread the free end of the rope through the block that was attached to the old downhaul rope in **step f**.

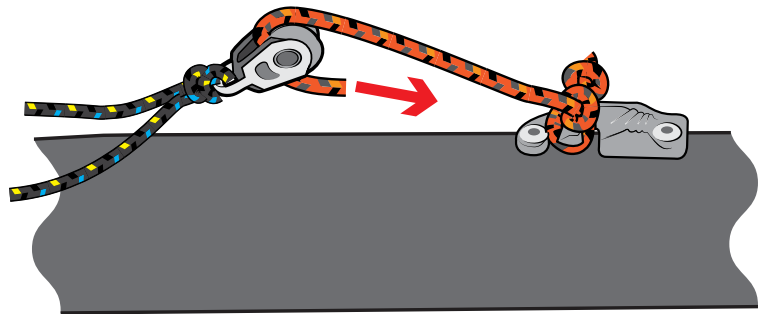

j)

Thread the rope forward through the cleat on the boom.

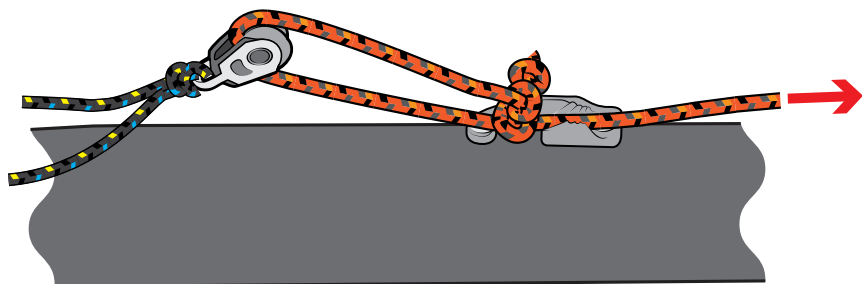

RS
tera 5.4 - Fitting the Performance Outhaul

k)

Thread the end through the block that was tied to the deck eye on the inboard end of the boom (in **step g**) and tie a large bowline in the end to act as a handle.

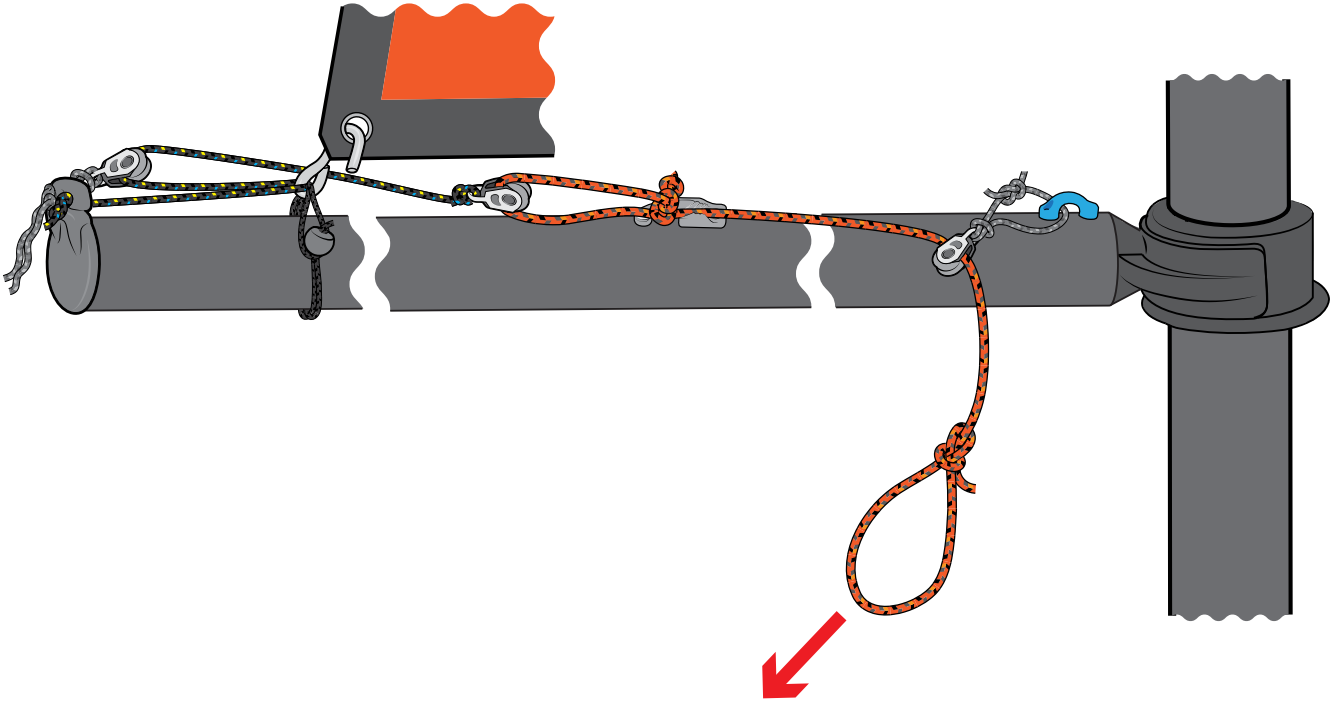

l)

Rig the boat and test the control functions. Adjust as necessary then cut off the excess line from the old downhaul rope and seal the end. You should need to cut off approximately 1m.

RS
Tera 5.5 - Top Cover

a)

The top cover is a very simple water-proof cover that can keep the spars and sails dry and out of sight when the boat is not in use. It is best to attach the top cover from the bow and work backwards, pulling the elastic drop cloth into place. There are a couple of tie points on the side.

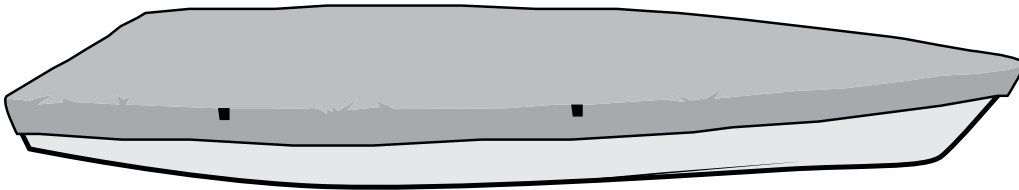

RS
Tera

6. Maintenance

RS
Tera

The RS Tera is made using Comptec PE3, a three-layer polyethylene construction. This is stiff and light, but will dent if subjected to point loading. The boat should be supported ashore on an approved RS trolley, as the hull may distort if not supported properly. For long-term storage, it is better to support the boat on a rack, in slings, or another type of support that spreads the weight and avoids point loads. The hull can also be stored on the transom, but never store the boat for long periods on its side. When dealing with a marine environment, equipment gets wet; this in itself is not a problem. The problem starts when moisture is trapped for any length of time. Therefore, it is very important to store the boat properly ashore.

Keep your dinghy drained and well ventilated

Ensure that the boat is stored with the bow raised to allow water to drain away.

Wash with fresh water

Fresh water evaporates far more quickly than salt water so if your dinghy has been sailed in salt water, rinse it thoroughly. The fittings will also work better if regularly washed. Any stubborn marks on the hull can be removed with a light detergent, such as washing up liquid. Always test cleaning products on a small, inconspicuous part of the deck before applying to the whole boat.

Hull damage falls into three categories:

- **SERIOUS** – large hole, split, crack, or worse. Don't be too distressed! Get the remnants back to RS Racing so we can assess the damage.
- **MEDIUM** – small hole or split. If this occurs during an event, sailing can often be continued as long as leaking can be prevented by drying the area and applying strong adhesive tape. CAUTION – if the damage is close to a heavily loaded point, then the surrounding area should be closely examined to ensure that it will accept the loads. Get the damage professionally repaired as soon as possible.
- **SMALL** – dents, scratching. This type of damage is not boat threatening.

Comptec PE3 cannot be repaired in the same way as fibre glass. Some scratching can be removed by RS Racing staff, but dents cannot. Therefore we suggest you treat your boat with as much care as you would if it were fibre glass. More serious repairs can be carried out by RS Racing staff; however, the repair will never be invisible, due to the nature of the material.

The joy of owning an RS Tera is that it is very hard wearing, and any dents and scratches it receives will not affect the structural integrity of the hull.

RS *Tera* 6.2 - Foil Care

RS Sailing foils are manufactured from anodised Aluminium extrusions with injection moulded glass reinforced Nylon ends. Lower mouldings are bonded in with polyurethane adhesive sealant. Upper mouldings are riveted or screwed in.

Lower mouldings are sealed, however over time there may be some water ingress. If this occurs foils should be inverted to allow water removal through the drain holes in the top of the moulding.

Foils contain closed cell foam to ensure buoyancy and limit potential water ingress.

Maintenance

- Foils should be rinsed with fresh water after use.
- Anodising will prevent surface corrosion, however if surface damage does occur the aluminium should be polished with wax polish e.g. car polish.
- Nylon mouldings are maintenance free and can be sanded smooth if damaged.
- If you run aground hard with the daggerboard down, you should check that the hull has not been punctured at the front or the trailing edge of the daggerboard case. Special 'shock absorbing' pads have been fitted at these points to reduce the risk of damage, and these can be replaced if damaged.

If you are going to trail your boat frequently, you may wish to invest in some RS Racing padded rudder bags. These will protect your RS Tera from any damage caused by the foils.

RS *Tera* 6.3 - Spar Care

The mast and boom are aluminium. Wash with fresh water as often as possible, both inside and out. Check all of the riveted fittings on a regular basis for any signs of corrosion or wear.

RS *Tera* 6.4 - Sail Care

The mainsail should be rolled and stored dry, out of direct sunlight. When using a new sail for the first time, try to avoid extreme conditions as high loads on new sailcloth can diminish the racing life of the sail.

If your sail is stained in any way, try to remove it using a light detergent and warm water. DO NOT attempt to launder the sail yourself.

A sail can be temporarily repaired using a self-adhesive cloth tape, such as Dacron or Mylar. The sail should be returned to a sail maker for a professional repair. Check for wear and tear, especially around the batten pockets, on a regular basis.

RS
tera **6.5 - Fixtures and Fittings**

All of the fixtures and fittings have been designed for a specific purpose in the boat. These items may break when placed under any unnecessary load, or when used for a different function to their intended purpose. To ensure optimum performance, wash the fixtures and fittings with fresh water regularly, checking shackles, bolts, etc. for tightness.

1. This warranty is given in addition to all rights given by statute or otherwise.
2. RS Sailing warrants all boats and component parts manufactured by it to be free from defects in materials and workmanship under normal use and circumstances, and the exercise of prudent seamanship, for a period of twelve (12) months from the date of commissioning by the original owner. The owner must exercise routine maintenance and care.
3. This warranty does not apply to defects in surface coatings caused by weathering or normal use and wear.
4. This warranty does not apply if the boat has been altered, modified, or repaired without prior written approval of RS Sailing. Any changes to the hull structure, deck structure, rig or foils without the written approval of RS Sailing will void this warranty.
5. Warranty claims for materials or equipment not manufactured by RS Sailing can be made directly to the relevant manufacturer. RS Sailing warrants that these parts were installed correctly and according to the instructions provided by the manufacturer.
6. Warranty claims shall be made to RS Sailing as soon as practicable and, in any event, within 28 days upon discovery of a defect. No repairs under warranty are to be undertaken without written approval of RS Sailing.
7. Upon approval of a warranty claim, RS Sailing may, at its expense, repair or replace the component. In all cases, the replacement will be equal in value to the original component.
8. Due to the continuing evolution of the marine market, RS Sailing reserves the right to change the design, material, or construction of its products without incurring any obligation to incorporate such changes in products already built or in use.

Knot #1



Knot #2



Knot #3



Knot #4



Knot #5



Knot #6



Knot #1 - Knot on knot

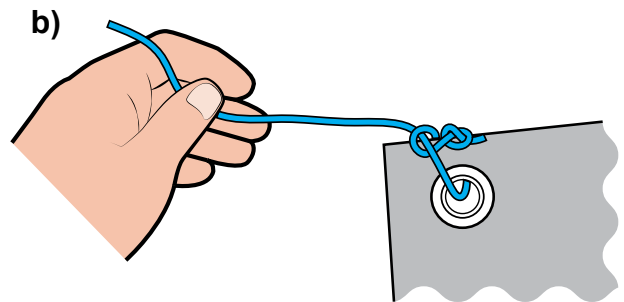
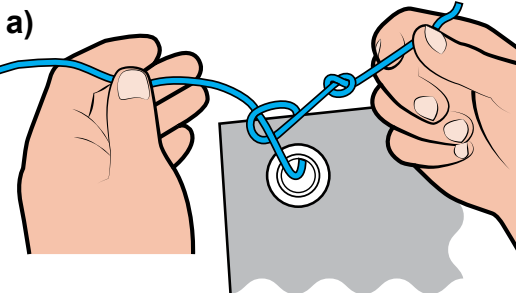

Knot #2 - Bowline

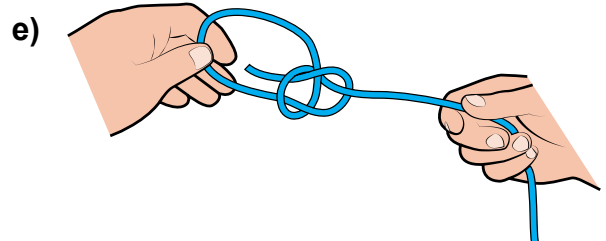
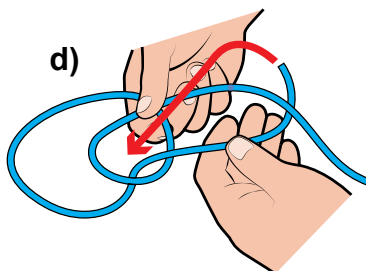
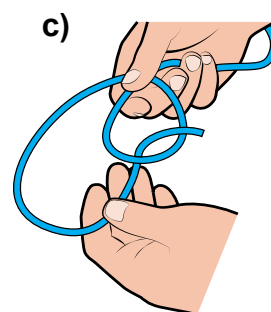
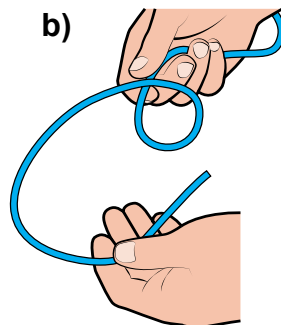
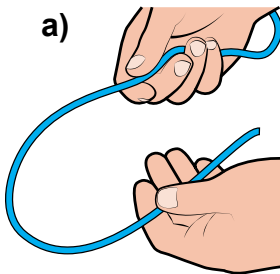

Knot #3 - Figure of eight

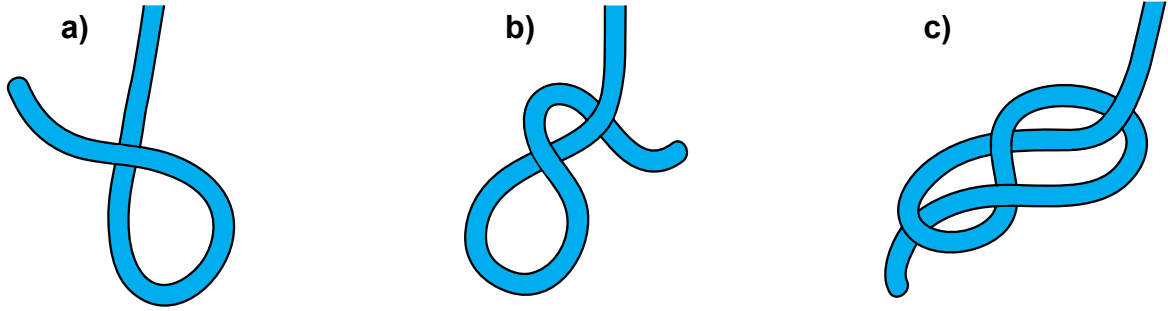

Knot #4 - Overhand knot

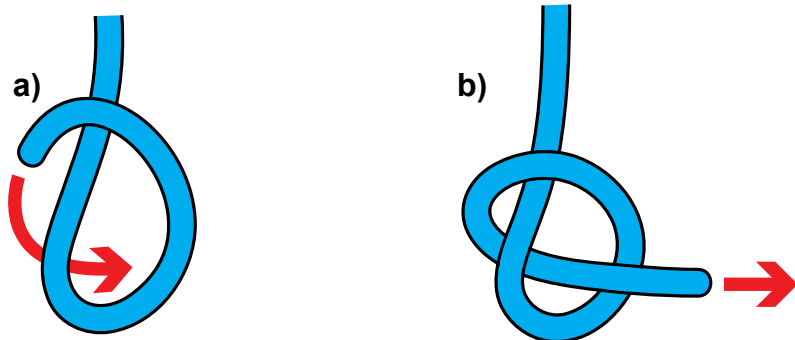

Knot #5 - Double sheet bend

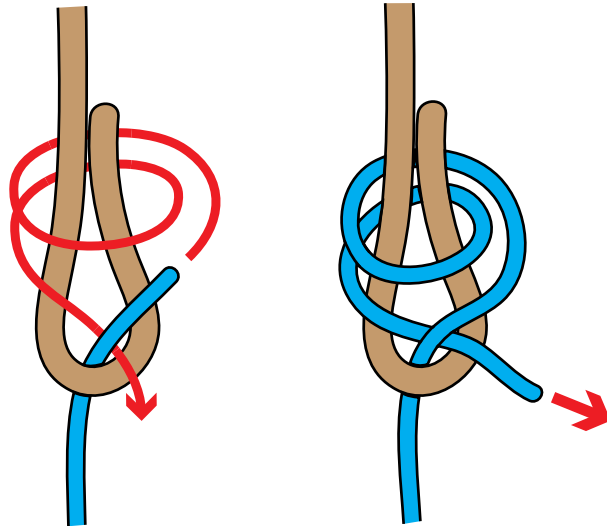

Knot #6 - Cow hitch

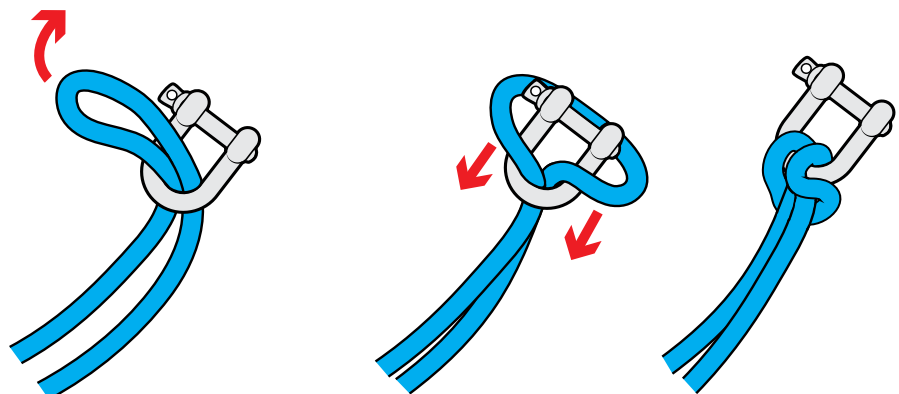

A

Aft	At the back
Anchor Line	Rope that attaches the anchor to the boat
Astern	Behind the boat
Asymmetric	Gennaker flown from a retractable pole at the bow

B

Back	To 'back the sail'; allowing the wind to fill the back of the sail
Bailer	A bucket or other container used for bailing water
Batten	A thin strip of wood/plastic inserted in the sail to keep it flat
Batten Key	A key used to adjust the batten
Batten Pocket	A pocket on the sail that holds the batten
Beam	Width of the boat at the widest point of the side of the boat. The phrase 'wind on the beam' means that the wind is coming from the side.
Bear away	To turn downwind
Beat	To sail a zig-zag course to make progress upwind
Beaufort Scale	A measure of wind strength, from Force 1 to Force 12
Bilge Rail	The moulded line that marks the transition from the side to the bottom of the hull
Block	A pulley used for sail control lines
Boom	The spar at the bottom edge of sail
Boom Pad	The pad that fits onto the boom
Bow	The front of the boat
Bow Lifting Handle	The handle at the front of the boat, used for lifting
Bowline	A useful and reliable knot, with a loop in it
Bow Snubber	The part of the trolley that the bow rests on
Builder's Plate	Plate that contains build information
Bung	A stopper for the drain hole

Buoy	Floating object attached to the bottom of sea – used variously for navigation, mooring, and to mark out a race course
Buoyancy Aid	Helps you to stay afloat if you fall in the water
Buoyancy Compartment	Water-tight compartment in the hull that maintains buoyancy
Burgee	Small flag at the top of the mast to show wind direction

C

Capsize	To overturn
Capsize Recovery	To right, or recover, the boat after a capsize
Catamaran	A boat with two hulls
Centreboard	The foil that sits below the hull to counteract the sideways push of the wind, and to create forward motion
Centreboard Case	The casing in the hull in which the centreboard sits
Centreline	An imaginary line that runs through the centre of the hull, from the bow to the stern
Chart datum	Depths shown on a chart, at the lowest possible tide
Cleat	A device to grip ropes and hold them in place – some grip automatically, while others need the rope tying around them
Clew	Lower corner of the sail, closest to the stern
Close hauled	Sailing as close to the wind as you can; point of sailing to sail upwind
Cockpit	The open area in the boat providing space for the helm and the crew
Collision Regulations	The 'rules of the road' to avoid collisions
Compass Rose	The compass shown on a chart to aid navigation
Crew	Helps the helmsman to sail the boat, and usually handles the jib sheets
Cutter	A boat with two headsails or jibs

D

Dacron	A brand of polyester sailcloth that is wrinkle-resistant and strong
Deck	A floor-like surface occupying part of the hull
Deck Moulding	A moulded deck
Downhaul	Applies downwards tension to a sail
Downwind	To sail in the direction that the wind is blowing
Drain Hole	A hole in the hull from which trapped water can be drained

Draught The depth of the vessel below the surface

E

Ease To 'ease sheets' means to let the sail out gently

F

Fairlead A pulley block used to guide a rope to avoid chafing

Foils The daggerboard and the rudder

Foot The bottom edge of a sail

Fore Towards the front of the boat

Forestay The wire line that runs from the front of the mast to the bow of the hull, holding the mast in position

Furl To gather a sail into a compact roll and bind it against the mast or forestay

G

Gennaker A large sail that is hoisted when sailing downwind

Gennaker Chute Webbing pocket in which the gennaker is stowed when not hoisted

Gennaker Pole The sprit that protrudes from the front of the hull, to which the tack of the gennaker is attached

Gnav Bar Bar that sits between the mast and the boom, performing the same function as a kicking strap

Gnav Control Line Line that applies and releases tension to the gnav

Gooseneck The 'jaws' of the boom that clip onto the mast

Gunwhale The top edge of the hull, that you sit on when leaning out to balance the boat

Gybe To change tack by turning the stern of the boat through the wind.

H

Halyard The rope used to hoist sails

Halyard Bag Bag attached to the hull, in which the halyards can be stowed

Head The top corner of a sail

'Head to Wind'	To point the bow in the direction that the wind is blowing from, causing the sails to flap
'Heave to'	To stop the boat by easing the main sheet and backing the jib
Heel	A boat 'heels' when it leans over due to the sideways force of the wind
Helm/Helmsman	The person who steers the boat, or another name for the tiller
Hoist Block	Block behind which the gennaker halyard is pulled when hoisting the gennaker
Hull	The hollow, lower-most part of the boat, floating partially submerged and supporting the rest of the boat

I

'Into the Wind'	To point the bow in the direction that the wind is blowing from, causing the sails to flap
Inversion	A capsized where the boat turns upside down, or 'turtles'

J

Jammer	Another word for a cleat
Jib	The small sail in front of the mast
Jib Sheet	The rope used to control the jib

K

Kicking strap	The rope system that is attached to the base of the mast and the boom, helping to hold the boom down
Knot	A measurement of speed, based on one minute of latitude

L

Launching	To leave the slipway
-----------	----------------------

Latitude	Imaginary lines running parallel round the globe from east to west. They help you measure position and distance on a chart.
Leech	The back edge of the sail
Leeward	The part of the boat furthest away from the direction in which the wind is blowing
Leeway	The amount of sideways drift caused by the wind
Leverage	The result of using crew weight as a 'lever' to counteract heel caused by the wind
Lie to	A way of stopping the boat temporarily by easing sheets on a close reach
Lifjacket	Unlike a buoyancy aid, a lifjacket will keep a person fully afloat with their head clear of the water
Longitude	Imaginary lines running round the globe from north to south, like segments of an orange. Used with lines of latitude to measure position and distance
Lower Furling Unit	The fitting at the bottom of the forestay that enables the jib to be furled
Luff	The front edge of the sail

M

Mainsail	The largest sail on a boat
Mainsail Clew Slug	The fitting that sits in the track on the boom, to which the clew of the mainsail is attached
Mainsheet	The rope used to control the mainsail
Mainsheet Bridle	The rope runs across the transom of the boat, to which the mainsheet is attached
Mainsheet Centre Block	The main block, usually fixed to the cockpit floor, through which the mainsheet passes
Man Overboard Recovery	The act of recovering a 'man overboard' from the water
Mast	The spar that the sails are hoisted up
Mast Foot	The bottom of the mast
Mast Gate	Fitting which closes across the front of the mast at deck level, holding the mast in place

Mast Lower Section	The bottom section of a two-piece mast
Mast Step	The fitting on the deck that the mast fits into
Mast Top Section	The top section of a two-piece mast
Meteorology	The study of weather forecasting
Moor	To tie the boat to a fixed object
Mylar	A brand of strong, thin, polyester film used to make racing sails

N

National Sailing Federation	Body that governs sailing in a nation. In the UK, this is the Royal Yachting Association
Navigation	To find a way from one point to the other
Neap Tide	Tides with the smallest tidal change

O

'Off the Wind'	To sail in the direction that the wind is blowing
Outboard Bracket Kit	Bracket which enables an outboard engine to be attached to the transom
Outboard Engine	Small portable engine that attaches to the transom
Outhaul	The control line that applies tension to the foot of the sail, by pulling the sail along the boom
Outhaul Hook	The fitting on the boom that hooks the eye at the back of the sail, and to which the outhaul is attached

P

Painter	The rope at the bow used to tie the boat to a fixed object
Pontoon	A floating jetty to moor your boat to
Port	The left-hand side of the boat, when facing forwards

R

RS Dealer	A third-party who sells the RS range
Reach	Sailing with the wind on the side of the boat

Reef	To make the sails smaller in strong winds
Retaining Pin	On a trolley, to hold the launching trolley to the road base
Road Base	A trolley that you place your boat and launching trolley upon to trail behind a vehicle
Rowlocks	U shaped fittings that fix onto the gunwale and holds your oars in position while rowing
Rowlock Holes	The holes in the gunwhale into which the rowlocks fit
Rudder	The foil that, when attached to the stern, controls the direction of the boat
Rudder Blade	The large, rigid, thin part of the rudder
Rudder Downhaul	The control line that enables you to pull the rudder into place
Rudder Pintle	The fitting on the transom onto which the rudder stock fits
Rudder Stock	The top part of the rudder, usually including the tiller, into which the rudder blade fits, and which then attaches to the rudder pintle
Run	To 'run with the wind', or to sail in the direction that the wind is blowing

S

Safety-Boat Cover	Support boats, usually RIBs, in case of emergency
Sail	An area of material attached to the boat that uses the wind to create forward motion
Sailmaker	A manufacturer of sails
Sail Number	The unique number allocated to a boat, displayed on the sail when racing
Sail Pressure	A sail has 'pressure' when it is working with the wind to create motion
Sailing Regatta	An event that usually comprises of a number of sailing races
Shackle	A metal fitting for attaching ropes to blocks, etc.
Shackle Key	Small key used to undo tight shackles
Sheet	A rope that controls a sail
Shroud	The wires that are attached to the mast and the hull, holding the mast up
Side Safety Line	The line that runs along the side of the hull
Single Handed	To sail a boat alone
Single-Line Reefing System	An efficient method of reefing with one line

Slider	Sliding fitting on the boom to which the gnav bar is attached
Soundings	The numbers on a chart showing depth
Spars	The poles, usually carbon or aluminium, to which the sail is attached
Spreaders	Metal fittings attached to the mast which hold the shrouds out
Spring Tide	The tides with the biggest range and strongest currents
Starboard.	The right-hand side of the boat, when facing forwards
Stern	The back of the boat
Stern Lifting Handles	The handles at the stern, used for lifting the boat
Stopper Knot	A form of knot used to prevent a rope from sliding through a fitting, such as a pulley or a cleat

T

Tack	a) To change direction by turning the bow of the boat through the wind b) The bottom front corner of a sail
Tack Bar	The bar at the bow of the hull, to which the tack of the jib is attached
Tack Line	The rope that emerges from the front of the gennaker pole, to which the tack of the gennaker is attached
Tender	A small vessel, usually used to transport crew to a larger vessel
Tidal height	The depth of water above chart datum
Tidal range	The difference between the depth of water at low and high tide
Tidal stream	The direction in which the tide is flowing
Tiller	The stick attached to the rudder, used to steer the boat
Tiller Extension	A pole attached to the tiller to extend its reach, usually used when hiking
Toe Straps	The straps to tuck your feet under when you lean out to balance the boat.
Top Furling Unit	Fitting at the top of the forestay which enables the jib to be furled
Towing Line	A rope attached to the boat, used to connect to a towing vessel
Transit	An imaginary line between two fixed objects, used to ensure that you are staying on course
Transom	The vertical surface at the back of the boat
Trim	Keeping the boat level fore and aft
Trimaran	A boat with three hulls
Trolley	A wheeled structure, used to move the boat around on land
Trolley Supports	The part of the trolley in direct contact with the hull

U

'Under Weigh' A term derived from the act of 'weighing' anchor, meaning to be in motion

Upwind To sail against the direction in which the wind is blowing

W

Wetsuit Neoprene sailing suit designed to keep you warm when wet

Windward The part of the boat closest to the direction in which the wind is blowing