

RS Zest

Rigging Manual V5

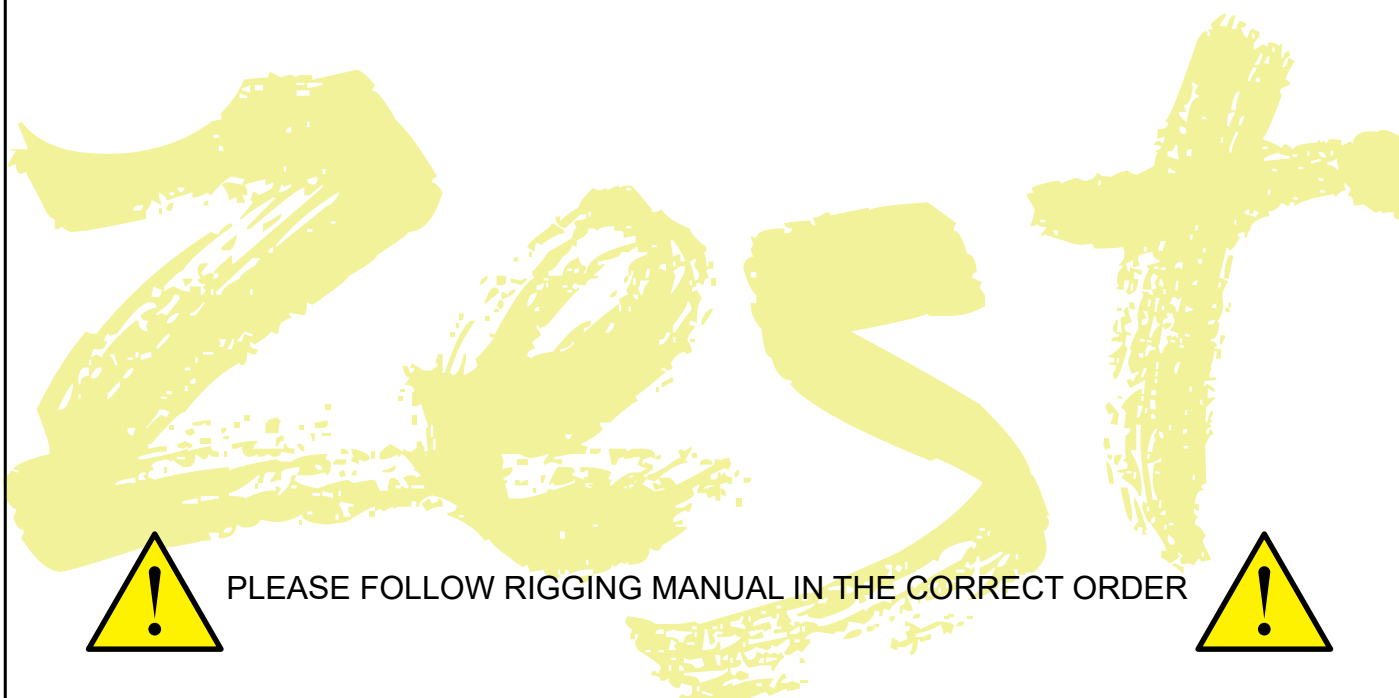

PLEASE FOLLOW RIGGING MANUAL IN THE CORRECT ORDER

Contents

| | |
|--|----------------|
| 1 - Introduction | 1 |
| 2 - Technical Data | 2 |
| 3 - Commissioning | 3 - 24 |
| 3.1 - Preparation | 4 |
| 3.2 - Unpacking | 4 |
| 3.3a - Boat Pack Contents | 4 - 5 |
| 3.3b - Customer Pack Contents | 5 |
| 3.3c - Jib Pack Contents (Optional) | 6 |
| 3.4a - Adding the Front Toestrap | 7 - 8 |
| 3.4b - Adding the Aft Toestrap | 9 - 10 |
| 3.5 - Rigging the Mast | 11 |
| 3.6 - Rigging the Jib Halyard | 12 |
| 3.7 - Stepping the Mast | 13 - 14 |
| 3.8 - Rigging the Vang | 14 - 15 |
| 3.9 - Adding the Boom | 15 |
| 3.10 - Downhaul | 16 |
| 3.11 - Outhaul | 16 - 17 |
| 3.12 - Rigging the Mainsheet | 18 - 19 |
| 3.13 - Rigging the Jib | 20 - 21 |
| 3.14 - Rudder | 22 - 23 |
| 3.15 - Centreboard | 24 |
| 4 - Sailing Hints | 25 - 29 |
| 4.1 - Introduction | 27 |
| 4.2 - Launching | 27 |
| 4.3 - Leaving the Beach | 27 |
| 4.4 - Sailing Close Hauled and Tacking | 27 |
| 4.5 - Sailing Downwind and Gybing | 28 |
| 4.6 - Reefing | 28 - 29 |
| 5 - Optional Accessories | 30 - 32 |
| 5.1 - Fitting the Jib Cleats and Fairleads | 31 |
| 5.2 - Fitting the Rowing Kit | 32 |
| 5.3 - Top Cover | 32 |
| 6 - Maintenance | 33 - 35 |
| 6.1 - Boat Care | 34 |
| 6.2 - Foil Care | 35 |
| 6.3 - Spar Care | 35 |
| 6.4 - Sail Care | 35 |
| 6.5 - Mast Gate | 35 |
| 7 - Knots | 36 - 37 |
| 8 - Warranty | 38 |
| 9 - Glossary | 39 - 47 |

1. Introduction

Congratulations on the purchase of your new RS Zest and thank you for choosing an RS product. We are confident that you will have many hours of great sailing and racing in this truly excellent design.

The RS Zest is an exciting boat to sail and offers fantastic performance. This manual has been compiled to help you to gain the maximum enjoyment from your RS Zest, in a safe manner. It contains details of the craft, the equipment supplied or fitted, its systems, and information on its safe operation and maintenance. Please read this manual carefully and be sure that you understand its contents before using your RS Zest.

This manual will not instruct you in boating safety or seamanship. If this is your first boat, or if you are changing to a type of craft that you are not familiar with, for your own safety and comfort, please ensure that you have adequate experience before assuming command of the craft. If you are unsure, RS, your RS dealer, or your national sailing federation – for example, the Royal Yachting Association – will be able to advise you of a local sailing school, or a competent instructor.

RS Sailing highly recommends using RS supplied equipment for usage and storing of your craft. Deviation from using RS supplied equipment, such as sails and storage solutions, will require consultation with RS Sailing. Failure to do so may affect Warranty claims and Goodwill outcomes

Please keep this manual in a secure place and hand it over to the new owner if you sell the boat.

For further information, spares, and accessories, please contact:

RS Sailing
Premier Way
Abbey Park
Romsey
Hants SO51 9DQ
Tel.: +44(0)1794 526760
Fax: +44(0)1794 278418
E-mail: www.info@rssailing.com

For details on your local RS dealer, please visit www.rssailing.com

2. *Zest* Technical Data

| | |
|----------------------|----------------------------|
| Length Overall (LOA) | 3.59m |
| Beam | 1.47m |
| Sailing Weight | 60kg |
| RS Zest Mainsail | 6.9m ² |
| Max Weight of Sailor | 100 kg |
| Designer | Jo Richards and RS Sailing |

RS
zest

3. Commissioning



PLEASE FOLLOW RIGGING MANUAL IN THE CORRECT ORDER



zest

Zest 3.1 - Preparation

Your RS Zest comes complete with all the components necessary to take the boat sailing.







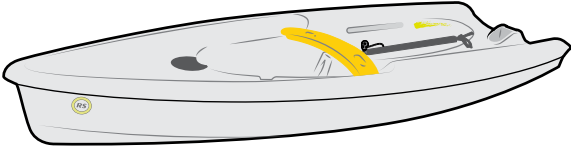

DO NOT use a knife or other sharp object to cut through packaging containing parts – you may damage the contents!

Whilst your RS Zest has been carefully prepared, it is important that new owners should check that shackles and knots are tight. This is especially important when the boat is new, as travelling can loosen seemingly tight fittings and knots. It is also important to check such items prior to sailing regularly.

Zest 3.2 - Unpacking

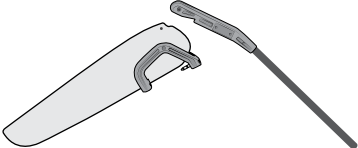
Having unpacked your RS Zest, you should check that you have all of the items listed before throwing away any of the packing, as there may be some small items still wrapped.



Zest 3.3a - Boat Pack Contents

| | | Quantity |
|---|---------------------|----------|
|  | Hull | 1 |
|  | Bottom mast section | 1 |
|  | Top mast section | 1 |
|  | boom | 1 |
|  | Rudder | 1 |
|  | Tiller extension | 1 |
|  | Fwd toerstrap | 1 |
|  | Aft toerstrap | 1 |
|  | Toerstrap elastics | 2 |

Zest









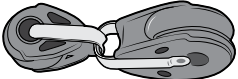

3.3a - Boat Pack Contents

Quantity

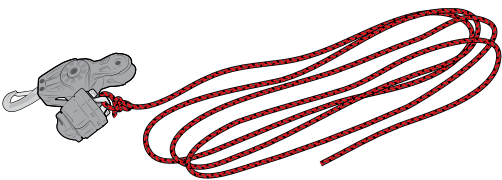

| | | |
|---|----------|---|
|  | Mainsail | 1 |
|  | Battens | 3 |

Zest

3.3b Customer Pack Contents

| | | |
|---|--------------------------------|---|
|  | Mainsheet | 1 |
|  | Centreboard retainer | 1 |
|  | Centreboard retainer hook | 1 |
|  | Mainsheet traveller block | 1 |
|  | Mainsheet bridle | 1 |
|  | 30mm block (vang) | 2 |
|  | Vang bottom block and rope | 1 |
|  | Vang block boom tie | 1 |
|  | Sleeved sail downhaul | 1 |
|  | plastic bobble (clew strap) | 1 |
|  | Clew strap | 1 |
|  | Mainsheet ratchet block (boom) | 1 |

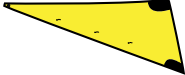
Zest**3.3c Jib Pack Contents (Optional)**

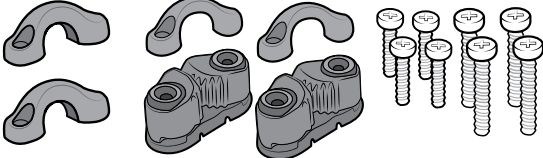
| | | |
|---|---------------------------------|---|
|  | Jib | 1 |
|  | Jib sheet | 1 |
|  | Jib halyard | 1 |
|  | Jib cleat, fairlead and screws. | 2 |

Zest

3.4a - Adding the Front Toestrap

- a) Locate the front toestrap.

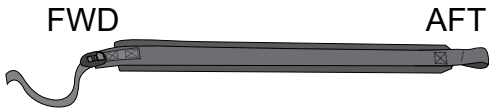

- b) Unscrew one end of the plastic toestrap fitting on the centreboard case just in front of the thwart.

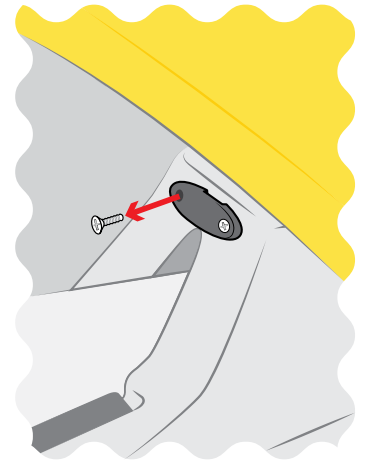

- c) Rotate the fitting to allow you to slip the webbing loop on the aft end of the toestrap over the fitting.

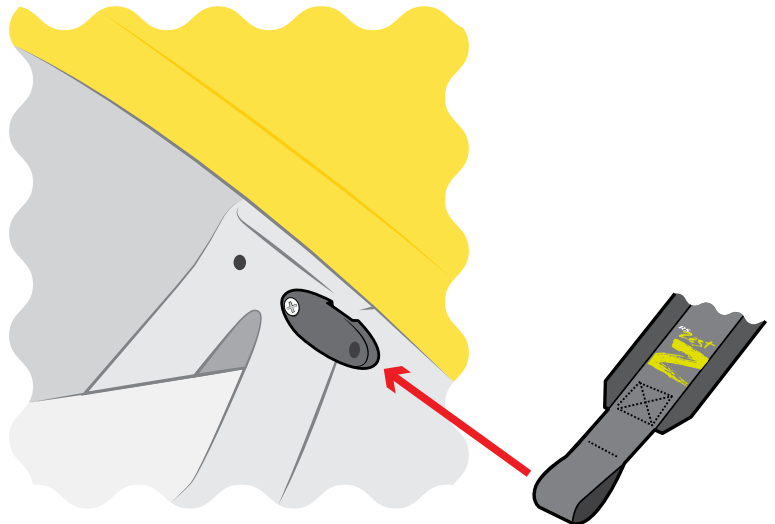
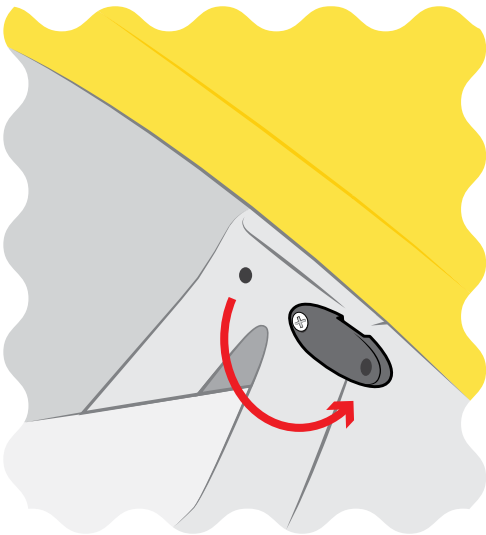

- d) Rotate the fitting and toestrap into place and replace the screw.

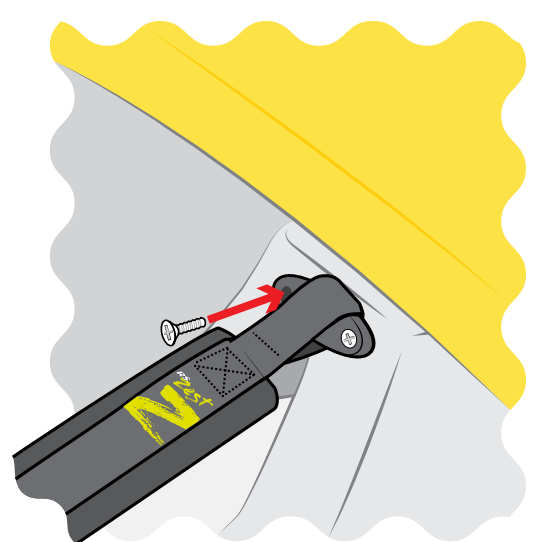
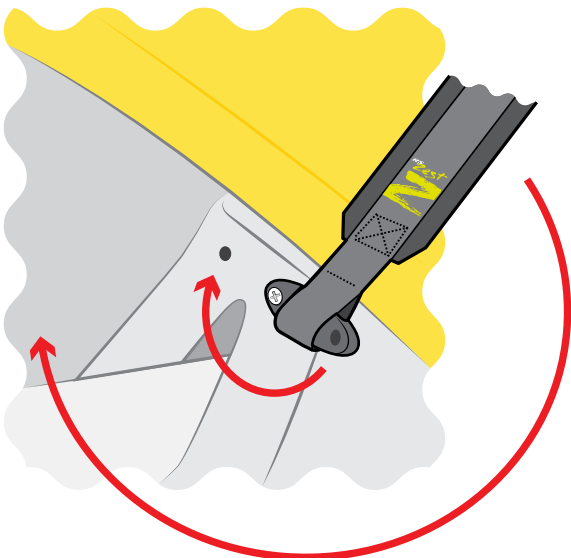

Zest

3.4a - Adding the Front Toestrap

- e) Attach the front end of the toestrap to the forward toestrap fitting using the buckle.

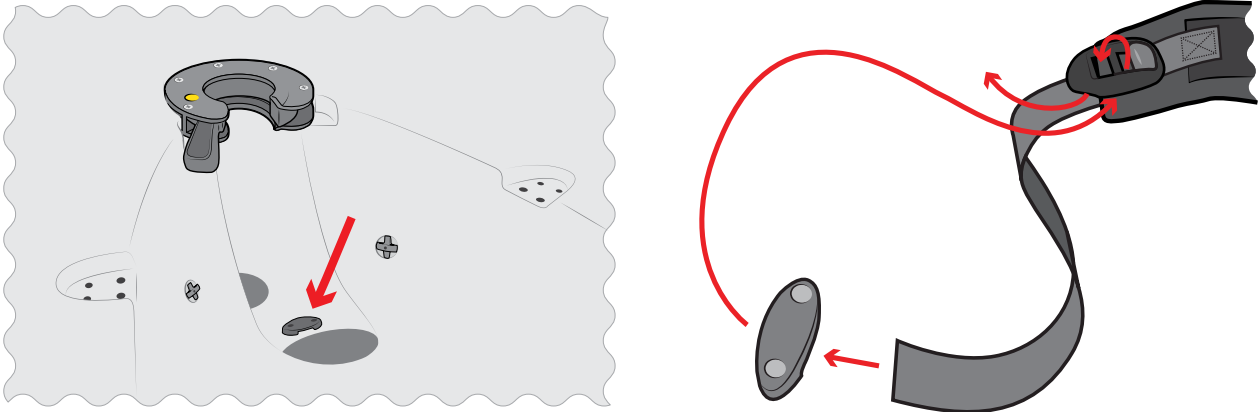

- f) Locate the front toestrap elastic and tie **knot #3** in one end.



- g) Pass the other end through the hole in the cross shaped plastic fitting on one side of the cockpit.

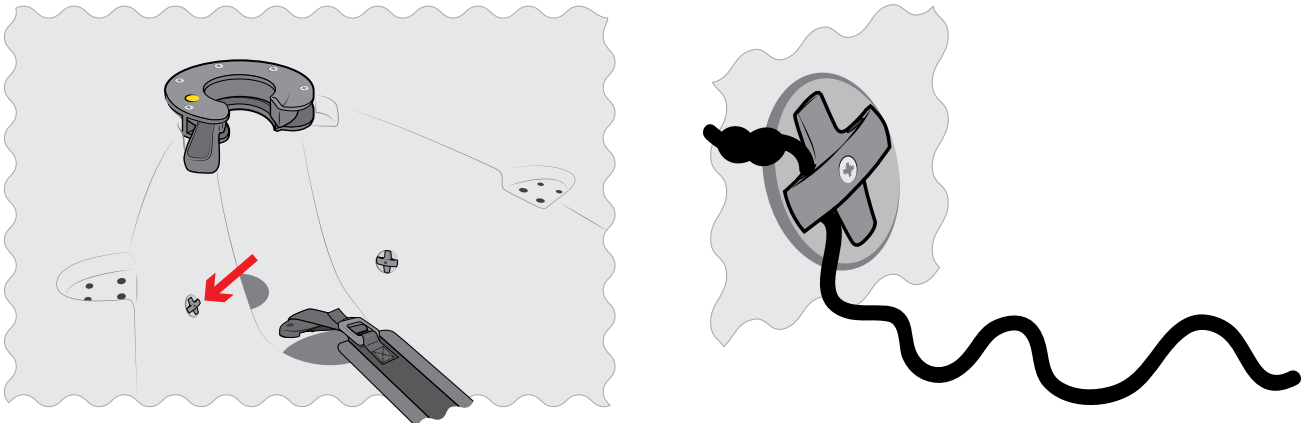

- h) Pass the elastic through the hole in the webbing (below the toestrap buckle) and through the fitting on the opposite side of the cockpit. Tie **knot #3** in the tail.

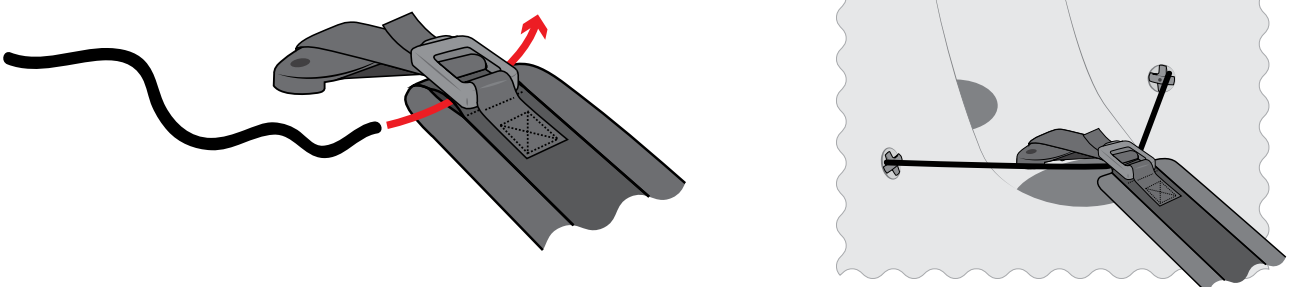

Zest

3.4b - Adding the Aft Toestrap

- a) Locate the aft toestrap.



- b) Unscrew one end of the plastic toestrap fitting which the mainsheet block is attached to.

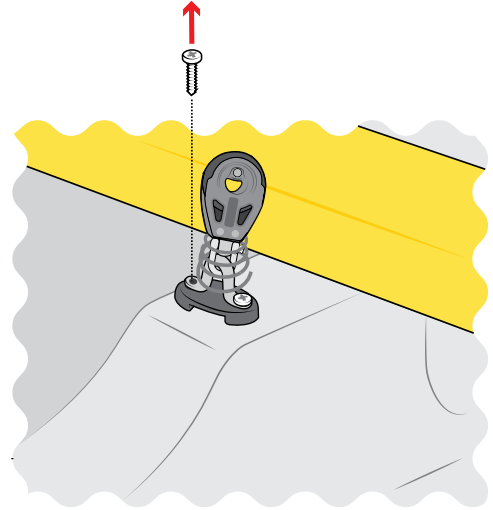

- c) Rotate the fitting to allow you to slip the webbing loop on the front end of the toestrap over the fitting.

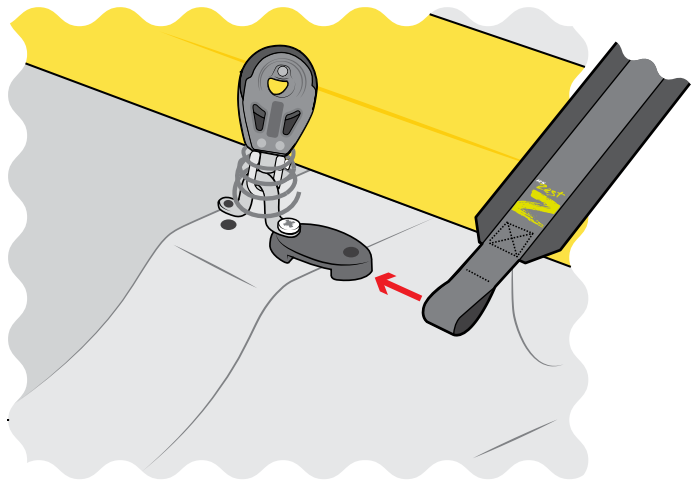
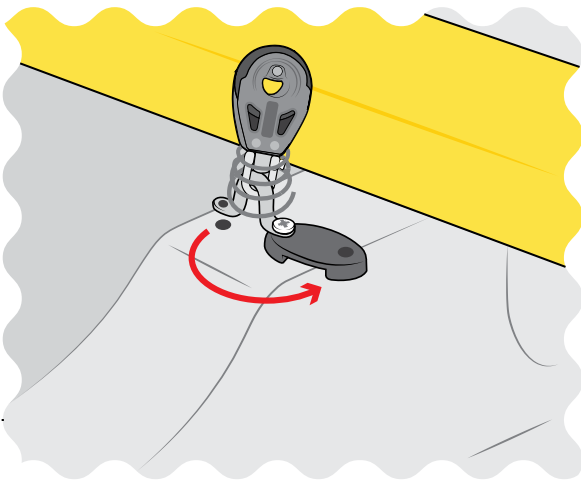

- d) Rotate the fitting (and toestrap) into place and replace the screw.

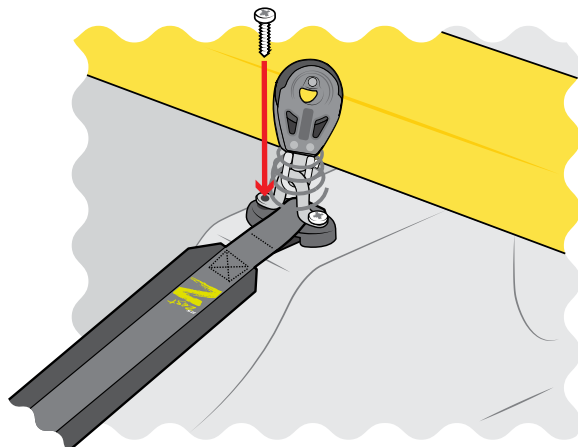

Zest

3.4b - Adding the Aft Toestrap

- e) Attach the aft end of the toestrap to the aft toestrap fitting using the buckle.

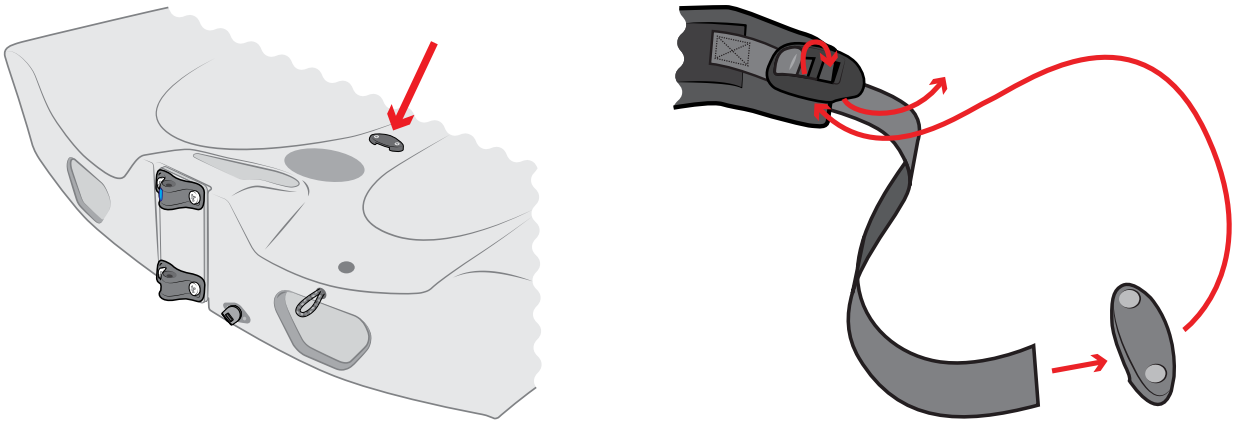

- f) Locate the aft toestrap elastic and tie **knot #3** in one end.



- g) Pass the other end upwards through the gap behind the top gudgeon on the transom.

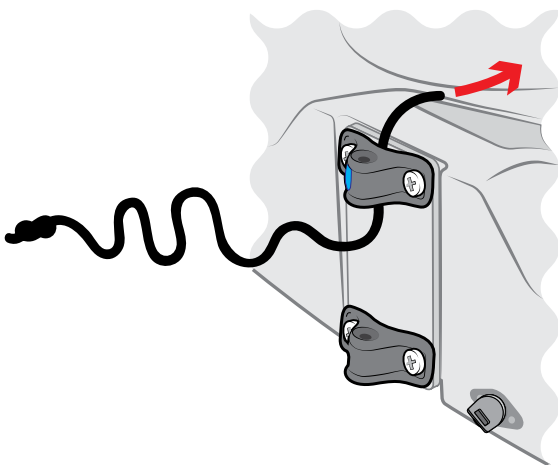

- h) Pass the end forward and through the hole in the webbing (beneath the toestrap buckle).

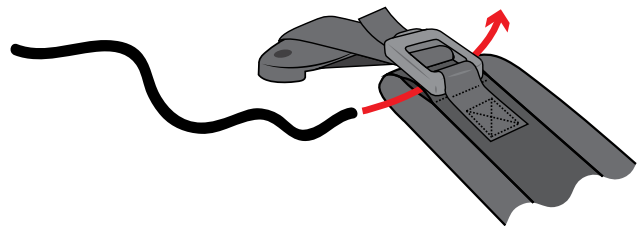

- i) Pass the end aft again and back through the gap behind the gudgeon, this time in a downward direction. Tie **knot #3** in the tail.

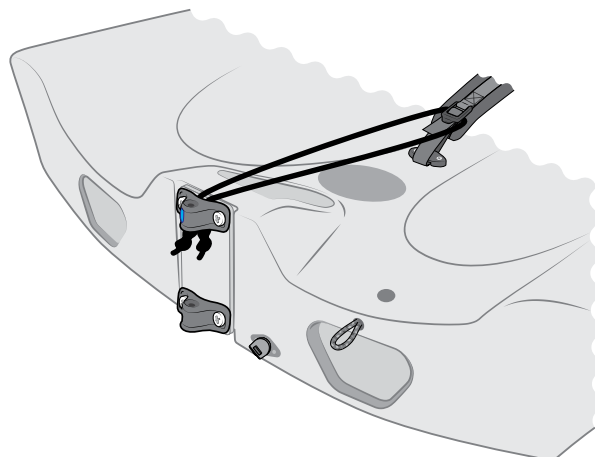

Zest 3.5 - Rigging the Mast

- a) Join the mast by inserting the mast top section into the mast lower section.

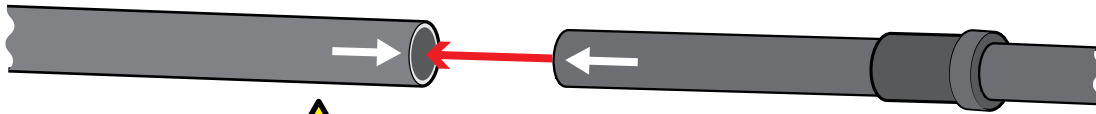

Make sure the arrows line up.

- b) Slide the front sleeve of the sail over the mast until the mast top reaches the top of the sail.

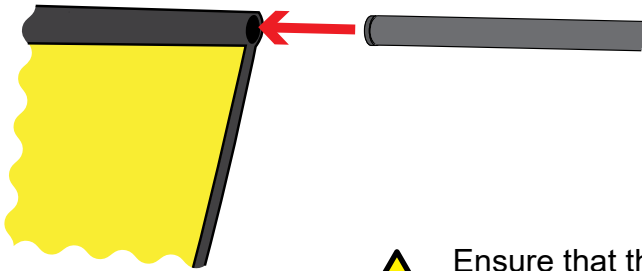

Ensure that the eye for the jib halyard is visible in the cut out.

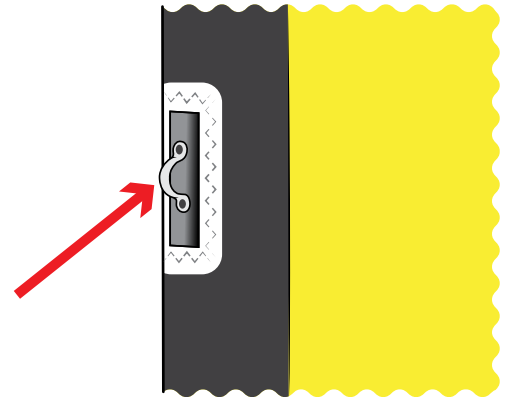

- c) Put the battens into the sail
- Battens are inserted with the curved end first. This engages against elastic in the pocket.

Push the batten into the pocket until it goes under the flap on the leech. You will need to overcome the resistance of the elastic.

To remove, push against the elastic until the batten will come out of the flap then remove.

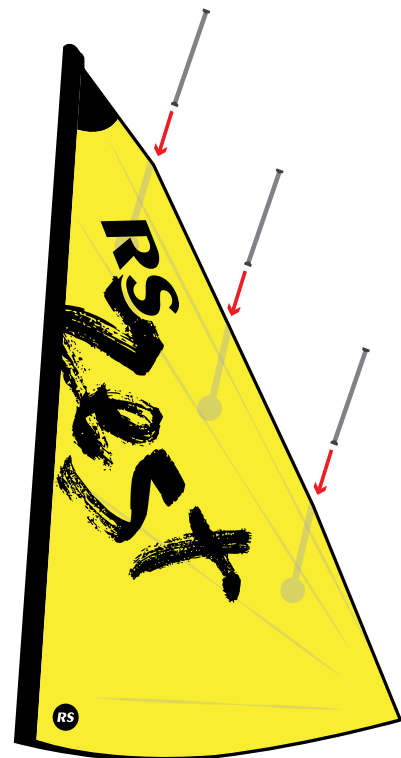

If you have the optional jib pack, move on to **section 3.6 - Rigging the Jib Halyard**.

If you do not wish to fit a jib move on to **section 3.7 - Stepping the mast**

Zest 3.6 - Rigging the Jib Halyard - OPTIONAL

The jib pack is available as an optional extra. If you do not wish to fit the jib, move straight on to section 3.7 (Stepping the mast).

In order to use the jib, you will need to fit the jib cleats and fairleads to the boat. See Section 5.1 for how to do this.

- a) Take the jib halyard from the jib pack.



- b) Thread one end of the jib halyard through the metal ring half way up the front of the mast and pull it through so that you have two equal tails by the gooseneck.

Secure the jib halyard tails.

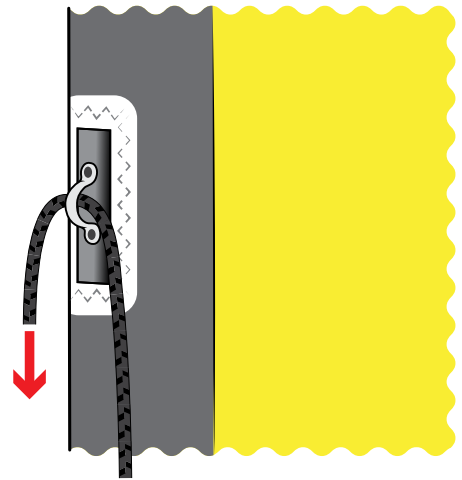

BEFORE PICKING UP THE MAST, CHECK THAT YOU ARE NOT IN THE VICINITY OF OVERHEAD POWER CABLES.

ANTES DE RECOGER EL MÁSTICO, COMPRUEBE QUE NO ESTÁ EN LA CERCANÍA DE LOS CABLES DE ELECTRICIDAD EXTENSOS.

PRIMA DI RAGGIUNGERE L'ALBERO, VERIFICARE CHE NON SIA NELLA VICINITÀ DEI CAVI DI ELETTRICITÀ A TESTA DI COMANDO.

ALVORENS DE MAST OP TE LADEN, CONTROLEERT U DAT U NIET IN DE NABIJHEID VAN ELEKTRISCHE KABELS VAN HET OVERHEAD WOONT.

BEVOR SIE DEN MAST AUFNEHMEN, ÜBERPRÜFEN SIE, DASS SIE NICHT IN DER UMGEBUNG VON ELEKTRIZITÄTSKABELN SIND.

AVANT DE RAMASSER LE MÂT, VÉRIFIEZ QUE VOUS N'ÊTES PAS À PROXIMITÉ DES CÂBLES ÉLECTRIQUES.

捡起桅杆之前，请检查您是否不在高架电缆的附近。

a)

Make sure the mast gate is open.

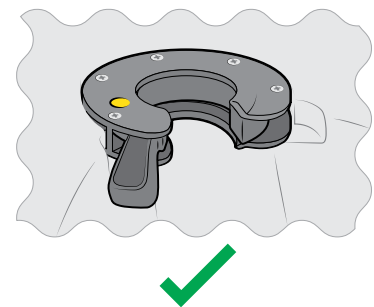
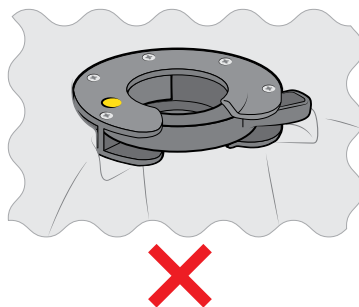

If the wind is blowing there will be a lot of pressure on the top of the mast making it wave around. Consider finding somebody to help if you feel that you will struggle.

b) Lift the mast into the boat and put the base of the mast into the mast pot.

c) Lift the mast upright into the mast gate. You can walk the mast up from the transom.

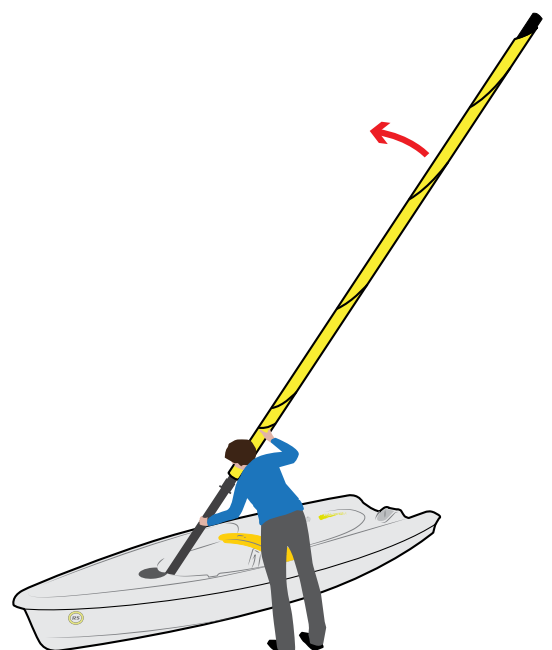

Zest**3.7 - Stepping the Mast**

d)

Close the mast gate.

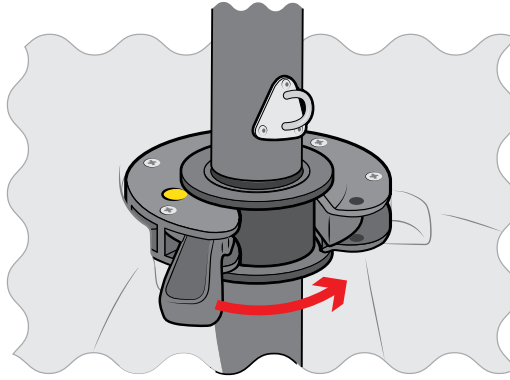

Make sure that it clicks into place and locks shut. In order to open the mast gate you must push the yellow button to release the lock.

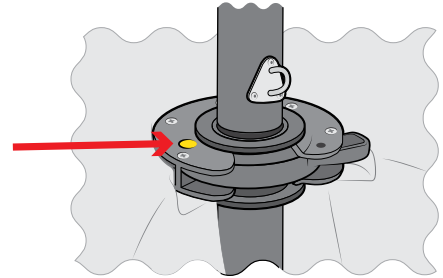

e)

Add the secondary pin through the hole in the mast gate.

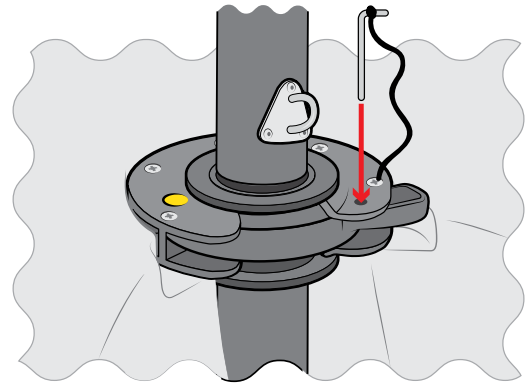
**Zest****3.8 - Rigging the Vang (Kicking Strap)**

a)

Locate the 2 x 30mm vang blocks, vang bottom block and rope.

Assemble the vang as shown.

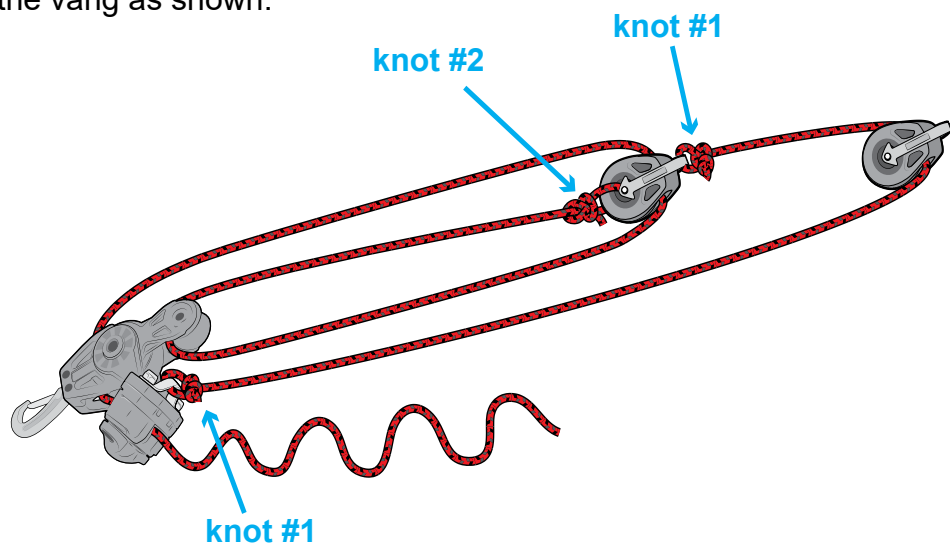

Zest 3.8 - Rigging the Vang (Kicking Strap)

- b) Locate the top block on the kicking strap.

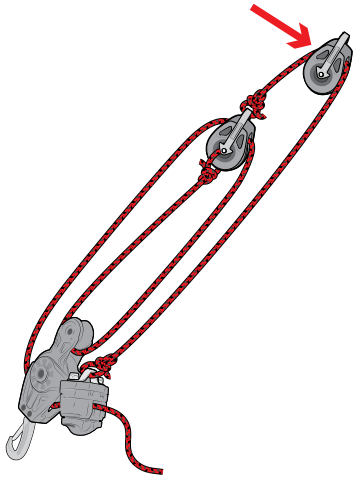

Tie the kicking-strap boom tie to the top block with **knot #1**.

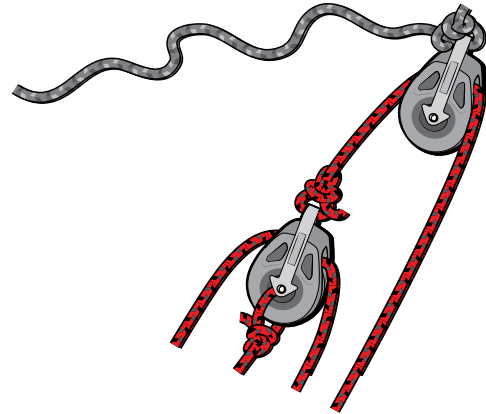

- c) Thread the kicking-strap boom tie through the eye on the boom, and tie **knot #3** in each end.

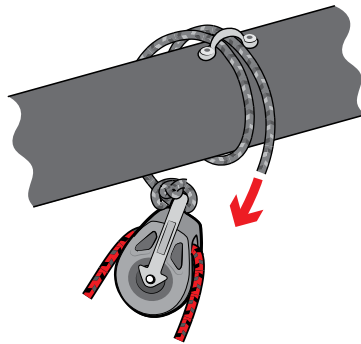

- d) Clip the hook on the bottom block of the kicker cascade onto the eye on the mast just above the mast gate.

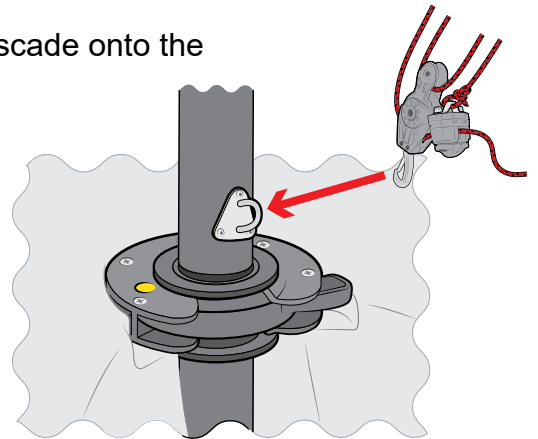

Zest 3.9 - Adding the Boom

- a) Take the boom and push the gooseneck onto the mast, just above the plastic sleeve.

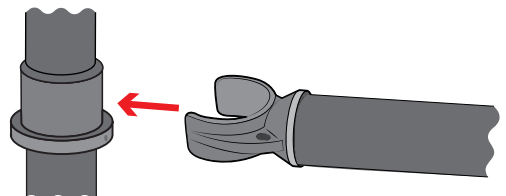

Zest 3.10 - Downhaul

- a) Tie the downhaul on to the cleat on the front of the mast with **knot #2**. Pass the tail through the metal ring on the sail sleeve, then back through the cleat.

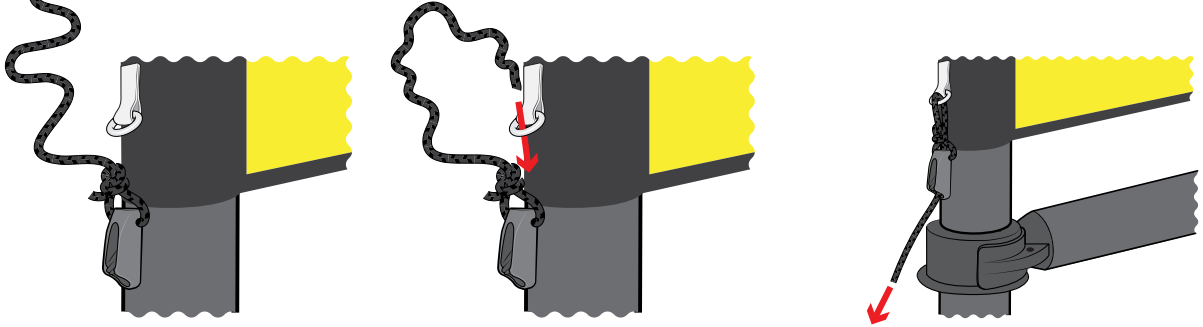

Zest 3.11 - Outhaul

- a) Locate the following items:

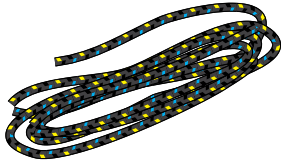

Outhaul line



Outhaul hook

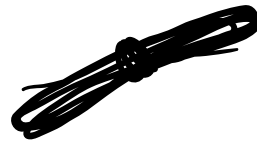

Outhaul elastic

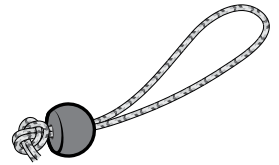

Clew strap

- b) Attach the outhaul line to the hook using **knot #1**.

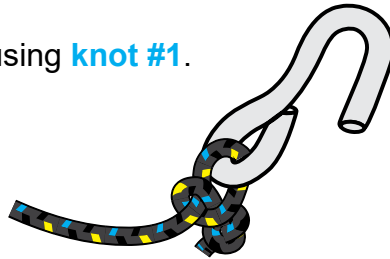

- c) Pass the other end through the bullseye at the aft end of the boom, forward through the cleat, then through the bullseye at the forward end of the boom.

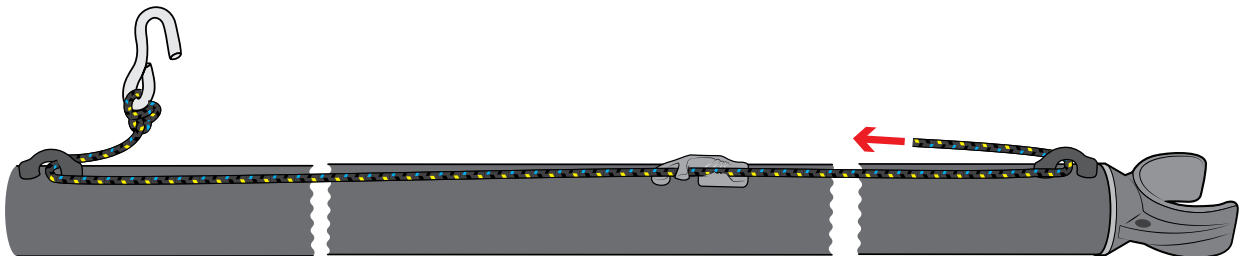

- d) Tie **knot #2** in the end of of the outhaul line.



e)

Tie the elastic to the hook with **knot #1**.

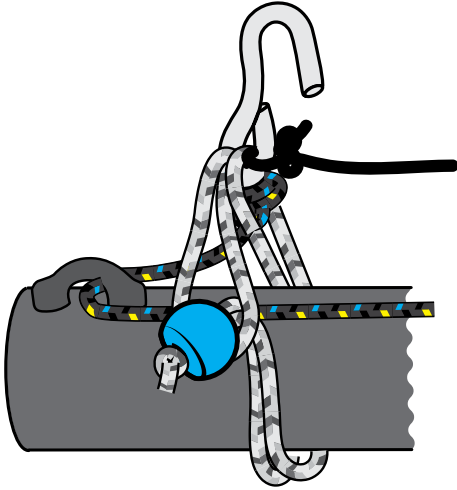

f)

Tie the other end of the elastic onto the end of the downhaul line with another **knot #2**.

Adjust the size of the loop on the knot to take up the slack.

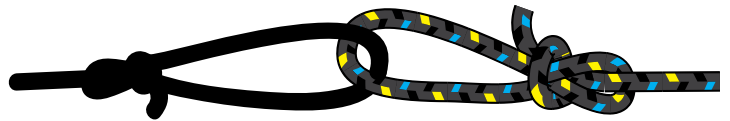

f) Add the clew strap.

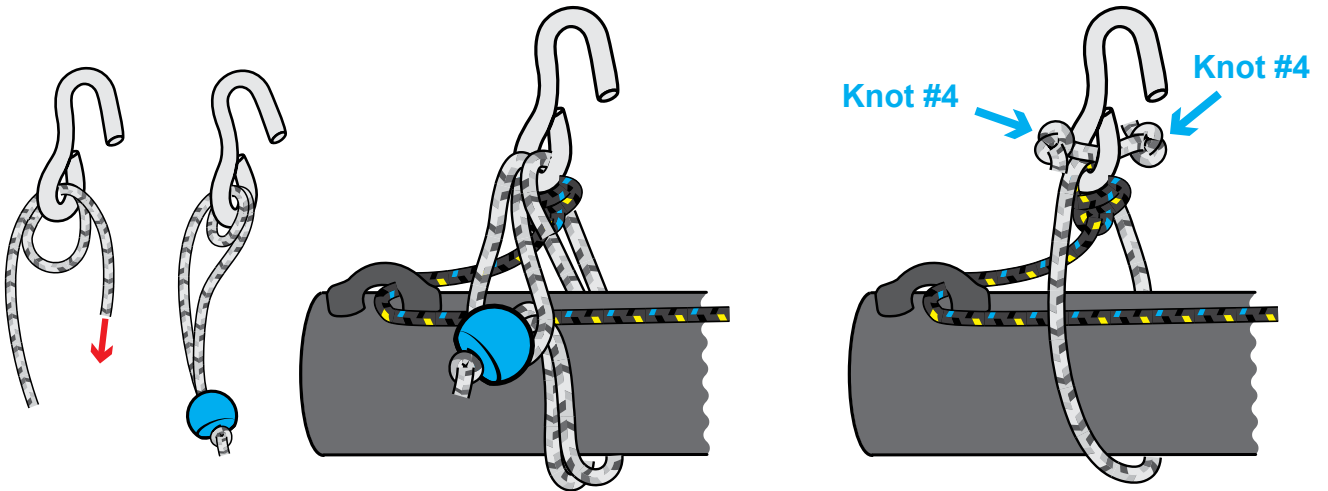

Boats made before late 2018

Late 2018 onwards

f) To use, hook the outhaul onto the clew, pull tight and cleat.

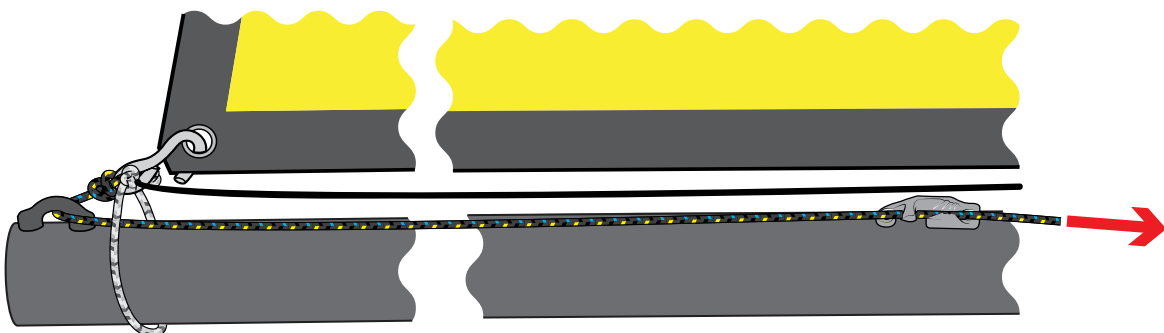

Zest 3.12 - Rigging the Mainsheet

- a) Locate the mainsheet traveller block and bridle.
- Thread the bridle through the bottom (smaller) block.



- b) Locate the mainsheet bridle in the rigging pack and tie it between the two plastic deck eyes at the sides of the cockpit (just aft of the thwart).

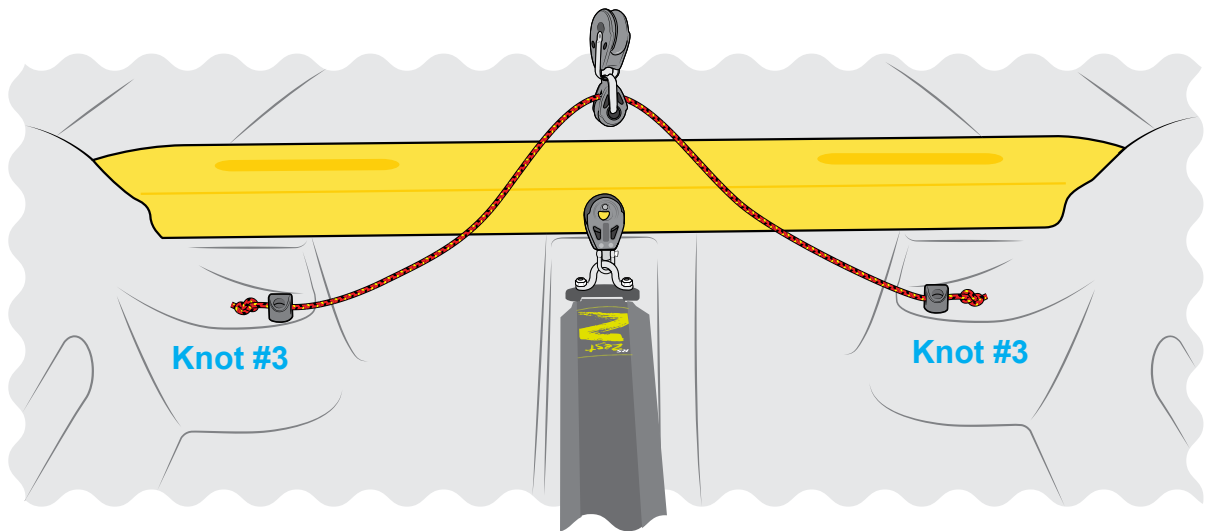

- c) Locate the mainsheet ratchet block in the customer fittings pack and shackle it to the boom. The block is designed to lock its rotation once shackled.



Make sure the block is in alignment with the boom and not rotated 90°.

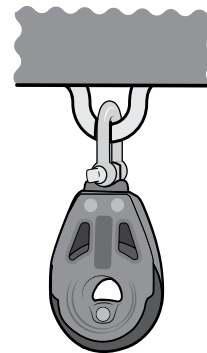

- d) Take one end of the mainsheet and tie it through the middle of the block which you just added with **knot #2**.



- e) There are two mainsheet blocks already attached to the boom. Take the free end of the mainsheet and pass it **forwards** through the front block on the boom.

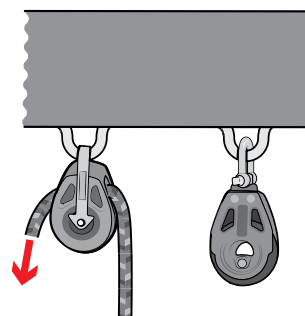

f)

Pass the end back down and through the block on the bridle (which you added in step b).

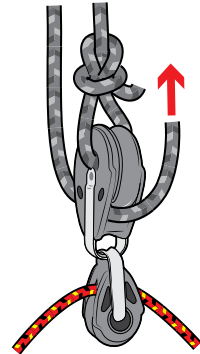

g)

Pass the end back up to the boom and through the ratchet block (the block furthest from the mast).



Make sure you pass the rope through the ratchet block in the correct direction. There is an arrow on the block to show this.

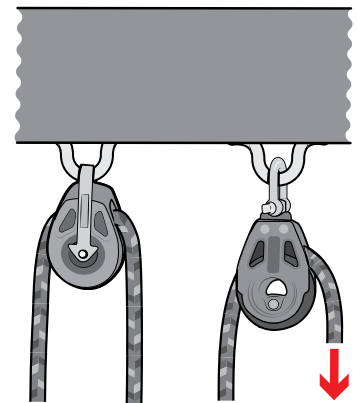

h)

Pass the end down through the mainsheet block in the centre of the cockpit (at the front of the toestraps) and tie **knot #3** in the tail.

Mainsheet System

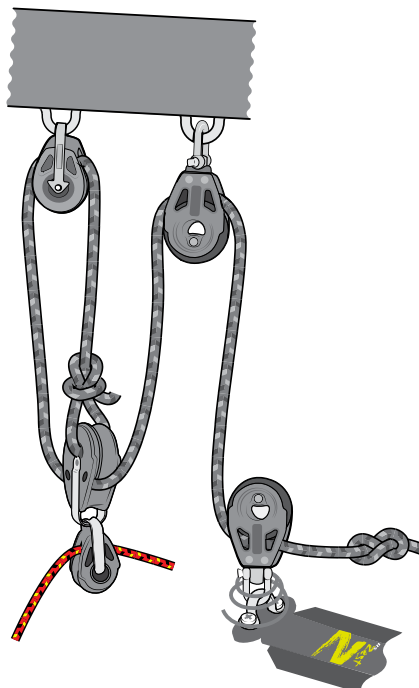

Zest 3.13 - Rigging the Jib

For this section, you will need:

- The RS Zest jib
- The jib halyard
- The jib sheet

Before the jib can be rigged for the first time, the jib cleats and fairleads must be added to the boat. See section 5.1 for how to do this.

a)

Unroll the jib.

There is a rope with a bobble attached to the tack of the jib.

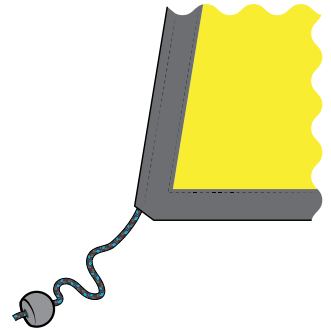

b)

Form a loop with this rope and pass it through the eye, then pass the loop over the bobble.

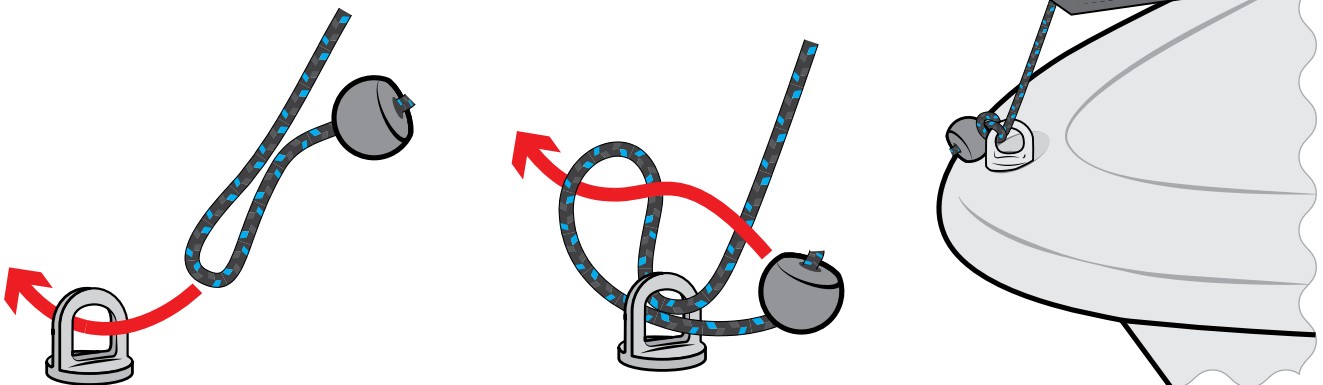

c)

Tie one end of the jib halyard onto the loop of rope sewn into the head of the jib, using **knot #1**.

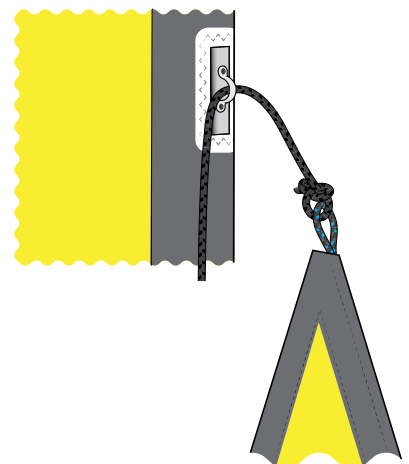

Zest

3.13 - Rigging the Jib

d)

Pull the jib up and secure the jib halyard in the cleat on the port side of the mast, below the gooseneck.



Only apply enough halyard tension to prevent the front of the jib from sagging whilst sailing.

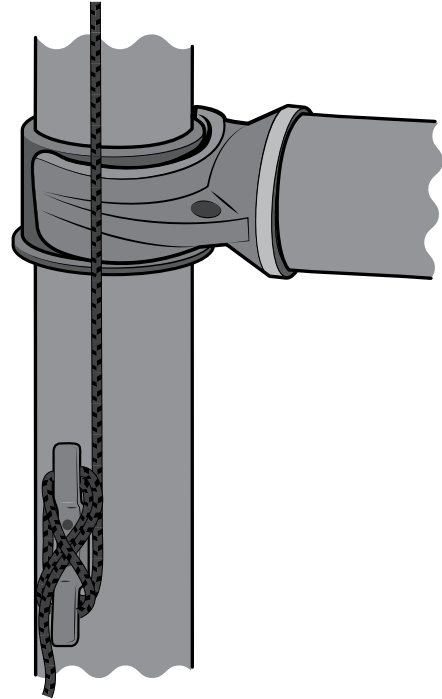

To complete this section you will need:

- The rudder pack
- A large flat-bladed screw driver

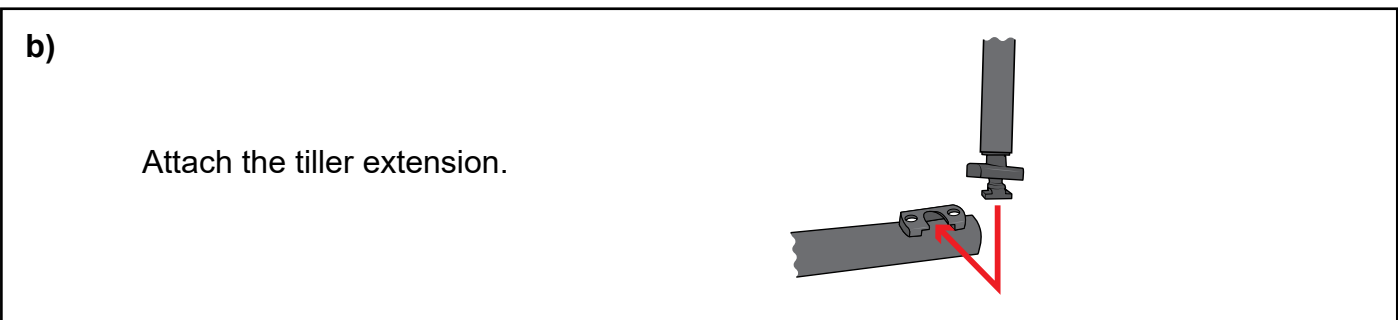
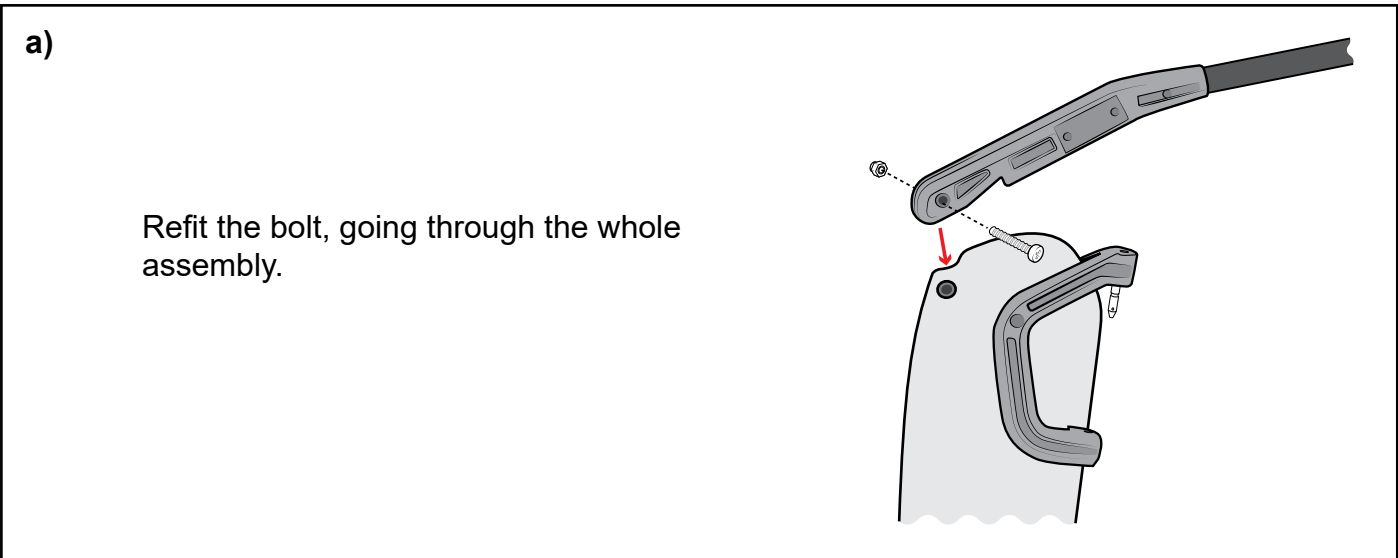
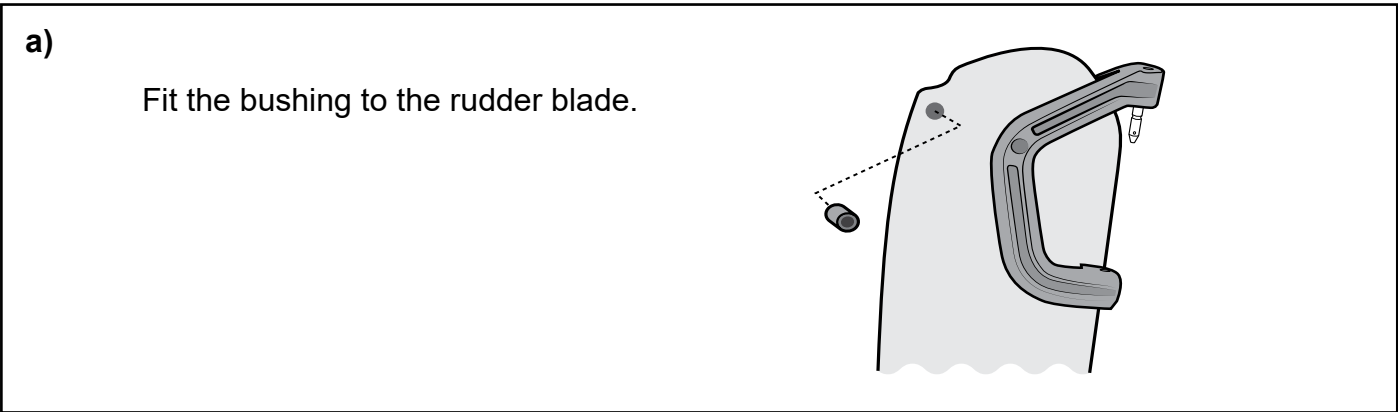
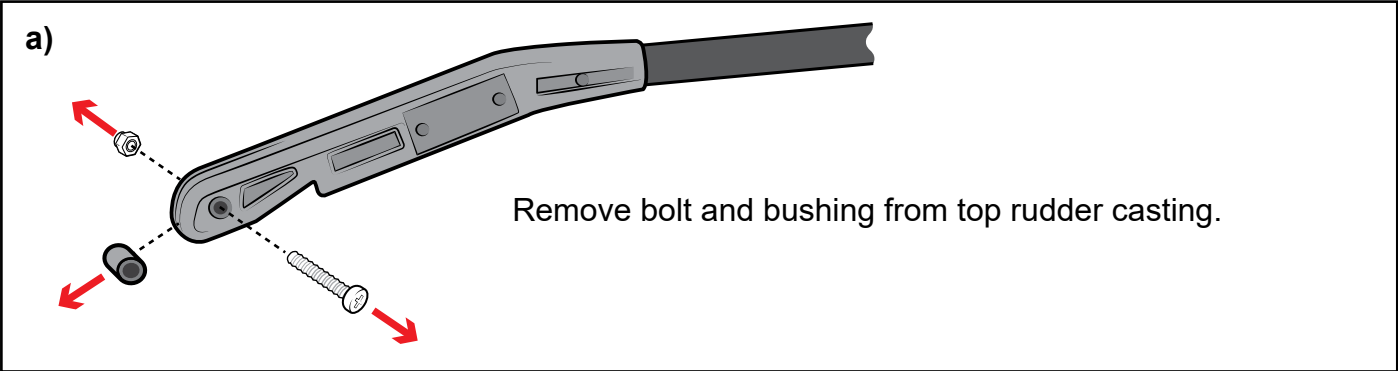

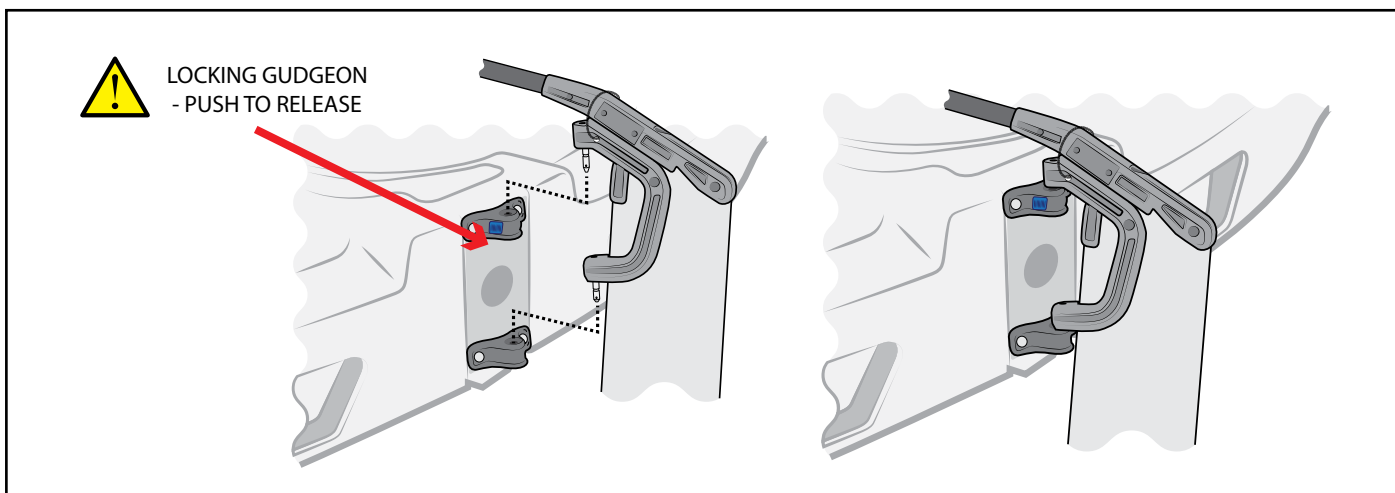

To put the rudder down -

1. Lift the tiller slightly to unlock the blade.
2. Push the tiller aft until the blade is fully lowered (it will normally 'clunk' into the front of the rudder stock).
3. Push the tiller firmly down to 'lock' the blade.

To pull the rudder up -

1. Lift the tiller slightly to unlock the blade.
2. Pull towards you (into the boat) until the blade reaches it's maximum up position.
3. Push the tiller gently down to hook over the top of the stock.



Do not paddle with the rudder half up.

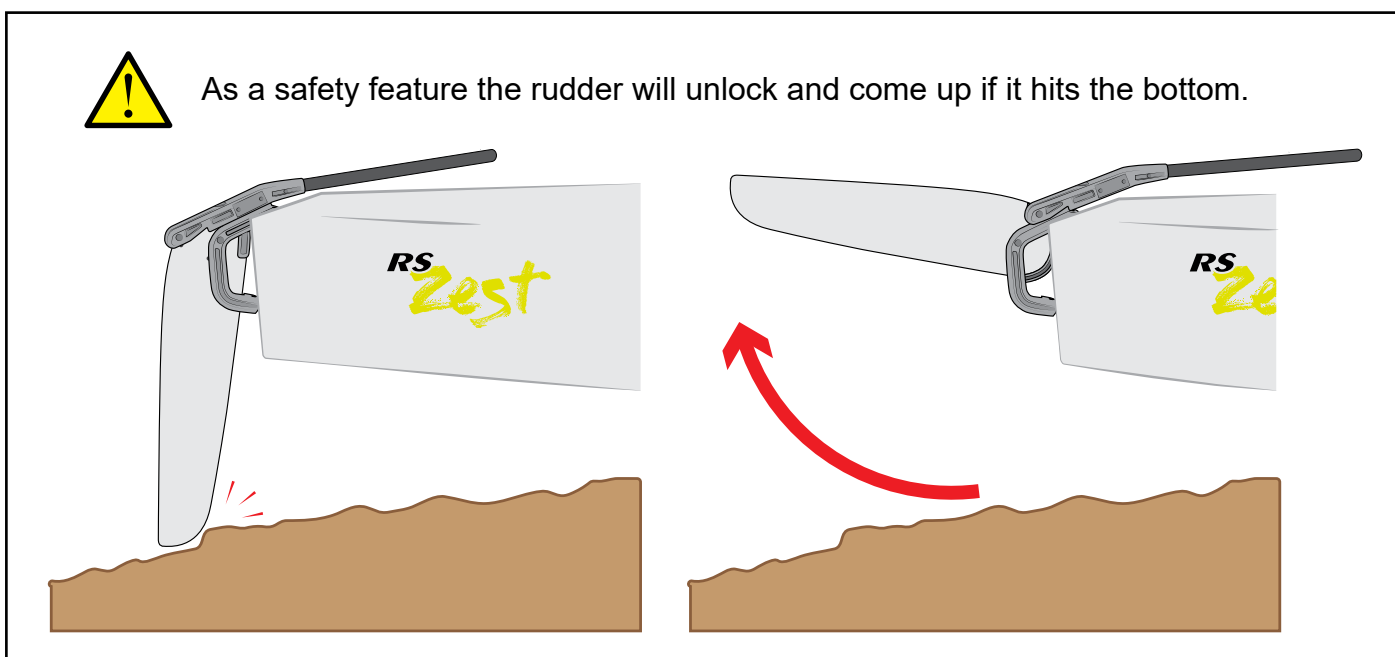

- a) Locate the centreboard elastic and plastic hook in the customer fittings pack.

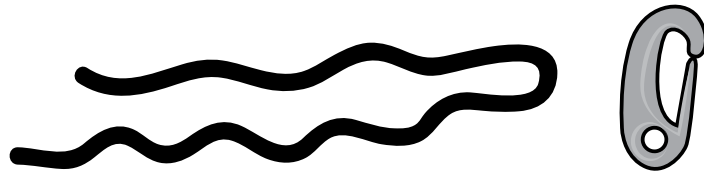

- b) Pass the elastic through the hole in the hook, then pass both ends through the toetraps fitting on the front of the thwart and tie **knot #3** in the tails to secure it in place.

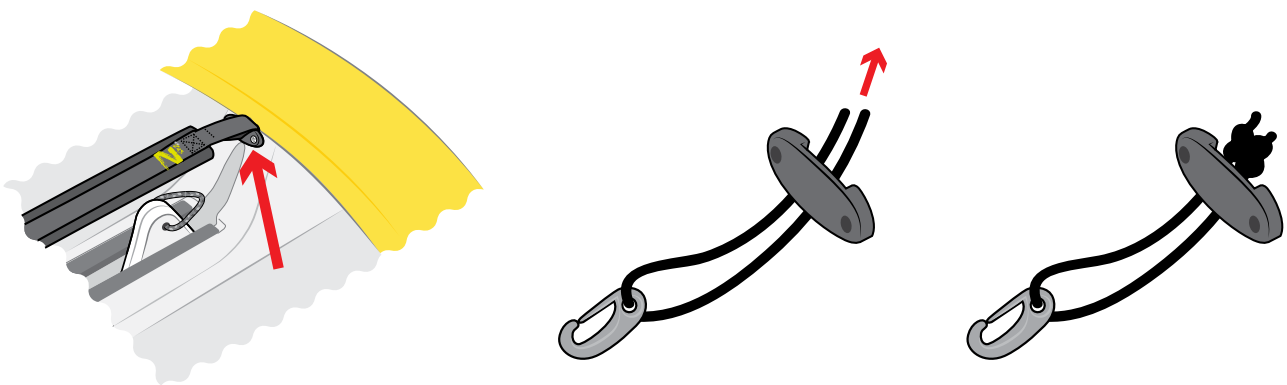

- c) Hook it onto the centreboard handle when the centreboard is in the fully down position.

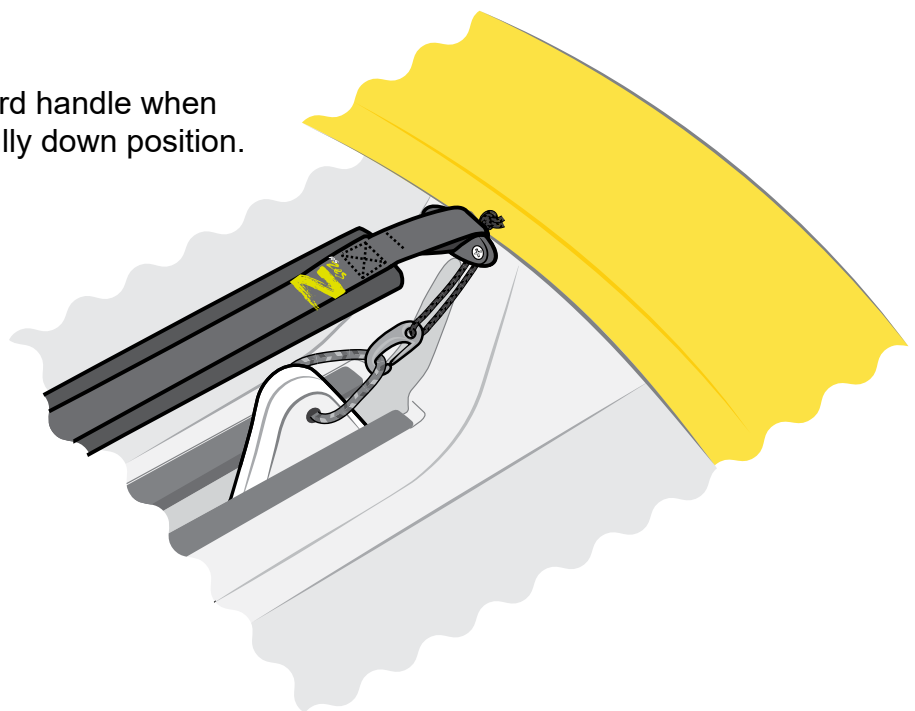

RS
zest

4. Sailing Hints



PLEASE FOLLOW RIGGING MANUAL IN THE CORRECT ORDER



TIME TO GO SAILING!!

After launching, the rudder is lowered by lifting the tiller and pushing it aft. The centreboard can be lowered once the water is deep enough. It is normally best to leave the kicking strap loose while launching, pulling it on as appropriate once you are sailing.

TOP TIP

Make sure that you lift the rudder and raise the centreboard before coming in.

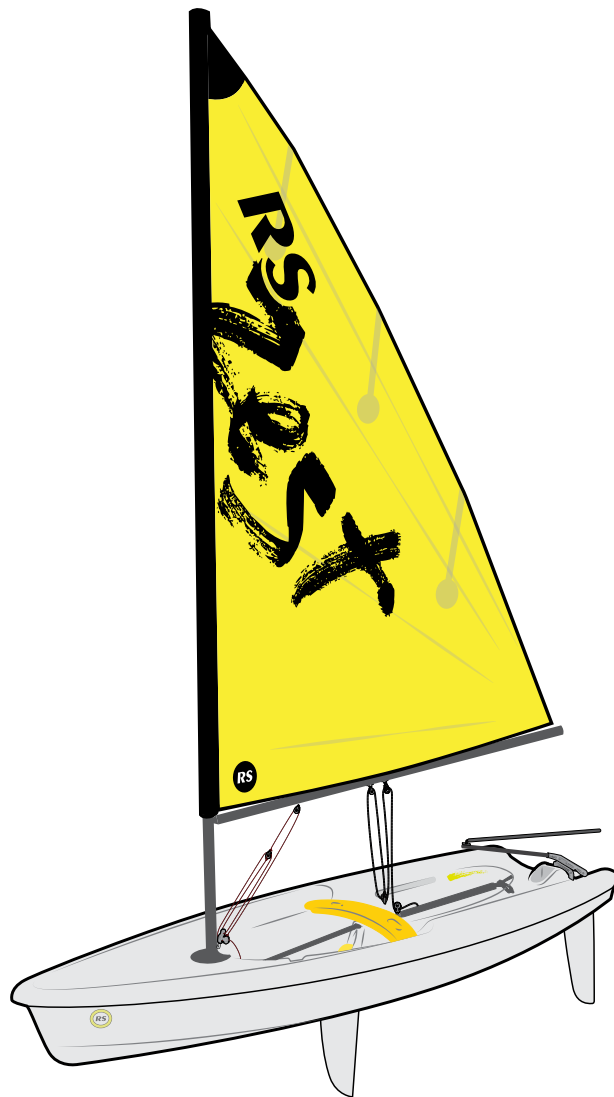

Zest 4.1 - Introduction

The RS Zest is a very rewarding boat to sail – to fully appreciate its handling, you should be comfortable with the basic techniques of sailing small boats. If you lack confidence or feel that a refresher is in order, there are many approved sailing schools which use the RS Zest. See www.rya.org.uk for more information.

While we offer you a few hints to aid your enjoyment of your new boat, they should not be considered as a substitute for an approved course in dinghy sailing. In order to build your confidence and familiarise yourself with your new boat, we recommend that you choose a fairly quiet day with a steady wind for your first outing.

Zest 4.2 - Launching

With the sails fully hoisted and the rudder attached to the transom, the boat should be wheeled into the water, keeping it head to wind as far as possible. If you have a crew, s/he can hold the boat head to wind whilst the trolley is stowed ashore.

If the tide is coming in as you launch, make sure that you leave the trolley far enough up the beach that it will not be swept away.

Zest 4.3 - Leaving the Beach

The easiest way to get going is for the helm to hop aboard while the crew holds the boat. The helm should put a little centreboard down, move back to their normal position, and pull gently on the rudder downhaul to lower some of the rudder blade.

Then, s/he may instruct the crew to push the bow off the wind and climb in. The crew will then lower the daggerboard as depth allows. The retaining elastic should be tied on as soon as possible to prevent the board falling out in the event of a capsize.

The singlehanded sailor may choose to ask someone to help them to launch. If launching alone, stand in the water alongside the gunwhale, holding the boat head to wind. Lower part of the daggerboard and rudder, and then push the bow off the wind while hopping in.

As soon the water is deep enough, make sure that you lower the rudder blade fully by pulling the rudder downhaul hard. You will know it is fully down if you feel a gentle "thud" as the front face of the blade hits the front face of the stock. Cleat the downhaul and tidy it by winding it around the tiller. Pull the sail in and you are away!

For the best performance, you should ensure that position yourself so that the boat is sailing through the water as flat as possible. Watch the trim (fore and aft) and the heel. The boat should always be sailed as upright as possible.

Top Tip

As a general rule, sit further forward in lighter winds and further aft in stronger breezes.

Zest 4.4 - Sailing Close Hauled and Tacking

When sailing close-hauled, or as close as possible to the wind, it is important to get the boom as near as possible to the centreline. The kicking strap should be firmly tensioned for upwind work. To pull it on, quickly put the boat head to wind. You should hold the tiller extension across your body, with a knuckles- up grip, enabling you to use one or two fingers as a temporary cleat when adjusting the mainsheet.

To tack, push the tiller extension away from you and, as the boat starts to turn, step across the cockpit facing forwards. Once the boat has completed the turn, bring the tiller back into the centre before sitting down on the new side, with the tiller extension behind your back. When you are settled, swap the mainsheet and the tiller extension into the new hands.

If the boat slows right down and feels lifeless when close-hauled, you could be sailing too close to the wind. Ease the mainsheet and 'bear off' away from the wind for a while to get the boat going again.

Zest 4.5 - Sailing Downwind and Gybing

When sailing downwind, the sail should be let out until about 90 degrees to the centre line. To gybe, pull the tiller towards you and, as the boat starts to turn, step across the cockpit facing forward. Once the boat has completed the turn, bring the tiller back into the centre before sitting down on the new side, with the tiller extension behind your back. Often, the boom will not want to come across until you have nearly completed the gybe, so it often pays to give the mainsheet a tweak to encourage the boom over at the moment that you want it to come! Once you are settled, swap the mainsheet and the tiller extension into the new hands.

Mind your head when you gybe!

Zest 4.6 - Reefing

a)

Leaving the downhaul in the cleat, unclip the kicking strap from the eye on the mast.

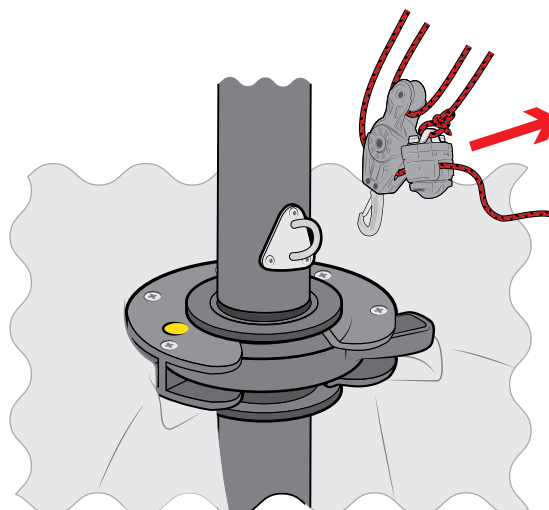

- b) Release the outhaul by removing it from the cleat on the boom, and pulling extra line through.

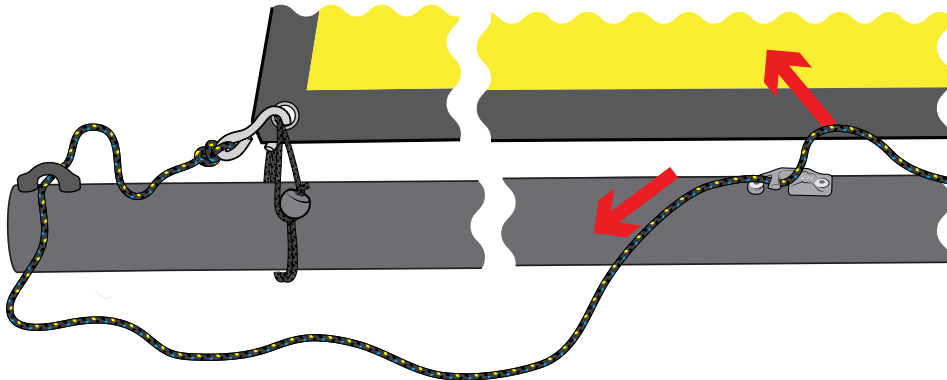

- c) Twist the mast so that the sail wraps around it, until you reach the appropriate size of sail.

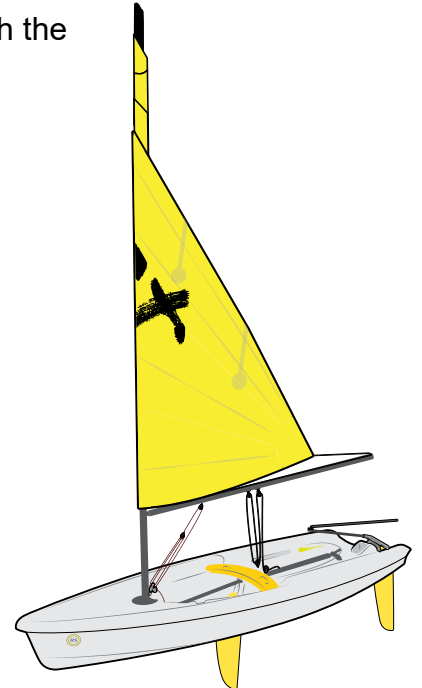
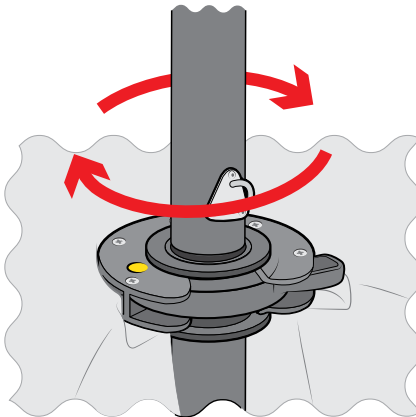
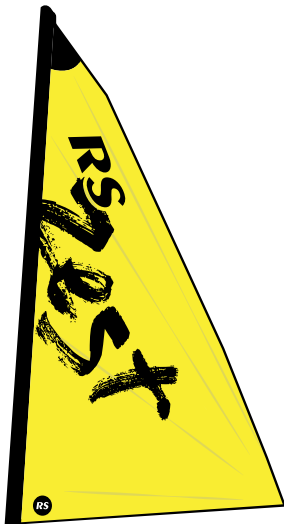

- d) Re-attach the kicking strap to the eye at the bottom of the mast and pull on the outhaul. You are now reefed and ready to sail!

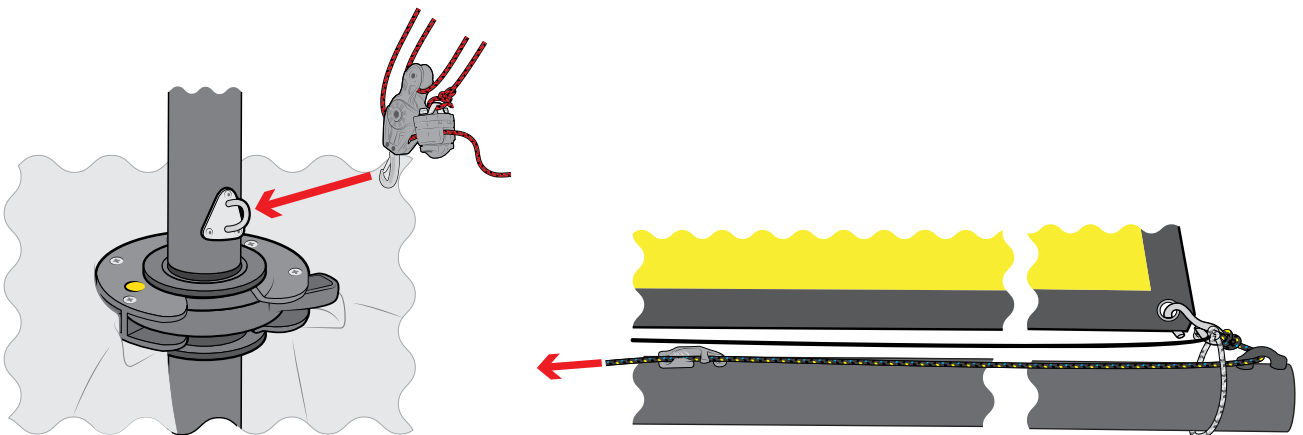

RS
zest

5. Optional Accessories



PLEASE FOLLOW RIGGING MANUAL IN THE CORRECT ORDER



zest

5.1 - Fitting the Jib Cleats and Fairleads

a)

Remove and dispose of the plastic plugs from the inserts.

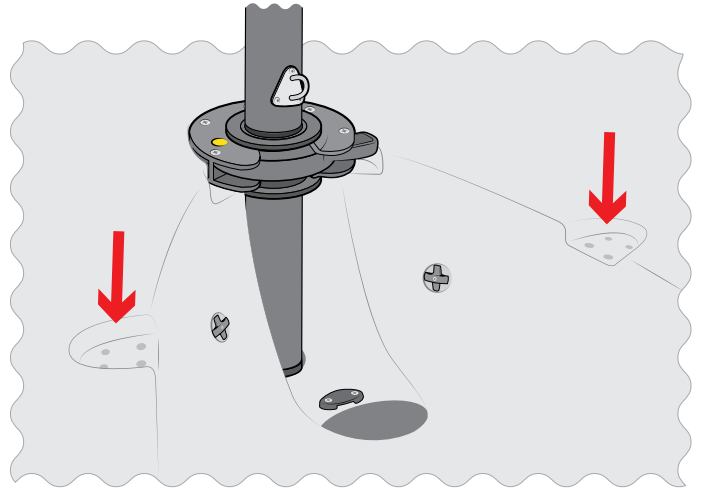

b)

Add the jib cleats and fairleads. Make sure the cleat opens towards you.



Do not overtighten.

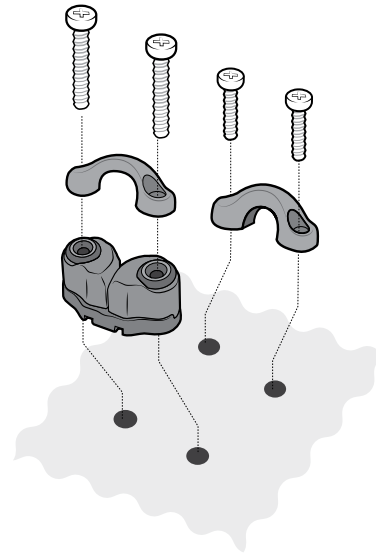

Zest 5.2 - Fitting the Rowing Kit

The RS Zest Rowing Kit may be purchased from RS Sailing or from your local RS Dealer, enabling you to use your sailing boat as a tender or small rowing vessel.

a)

Before using the oars for the first time you must fit the rowlock inserts into the recesses on the gunwhales using the screws provided.

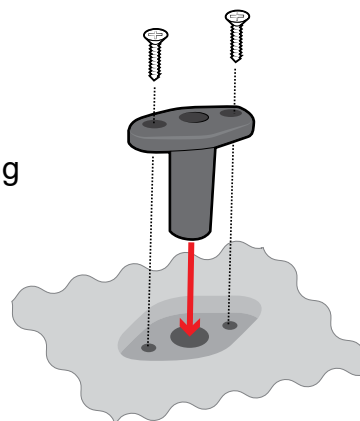

b)

To locate and lock the oars in position, push the spigot in the rowlock hole and rotate the complete oar, so that the paddle is over the cockpit and the handle is over the side of the boat.

As you turn the oar into the correct position, with the paddle over the side and the handle over the cockpit, you will feel the oar lock into place. The oar will not pull out. To release the oar, reverse the procedure.

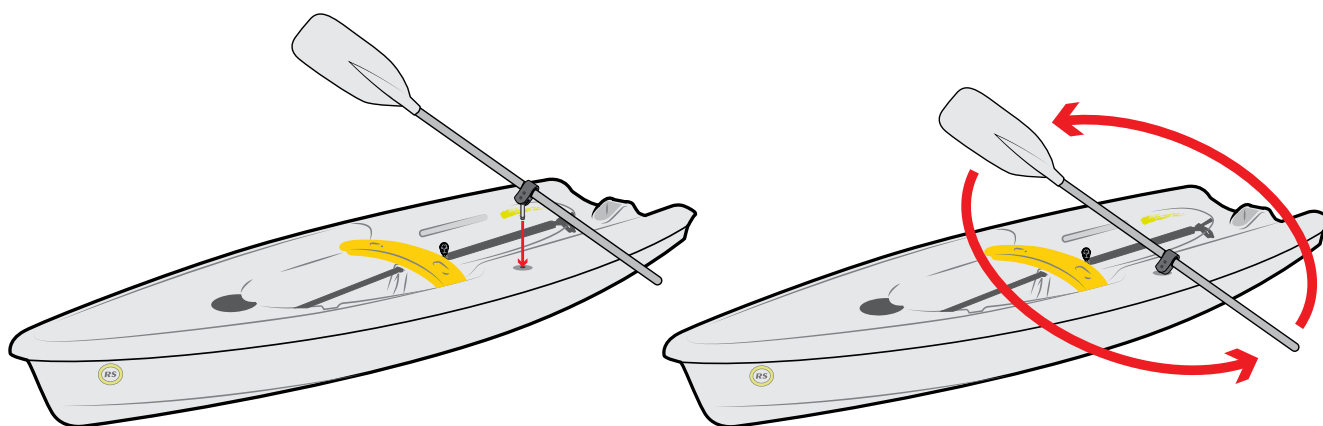

Zest 5.3 - Top Cover

a) The top cover is a very simple water-proof cover that can keep the spars and sails dry and out of sight when the boat is not in use. It is best to attach the top cover from the bow and work backwards, pulling the elastic drop cloth into place. There are a couple of tie points on the side.

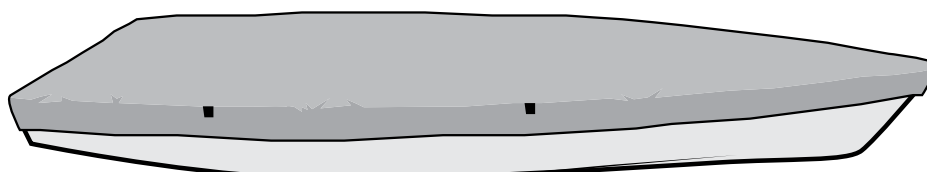

RS
zest

6. Maintenance



PLEASE FOLLOW RIGGING MANUAL IN THE CORRECT ORDER



zest

The RS Zest is made using Comptec PE3, a three-layer polyethylene construction. This is stiff and light, but will dent if subjected to point loading. The boat should be supported ashore on an approved RS trolley, as the hull may distort if not supported properly. For long-term storage, it is better to support the boat on a rack, in slings, or another type of support that spreads the weight and avoids point loads. The hull can also be stored on the transom, but never store the boat for long periods on its side. When dealing with a marine environment, equipment gets wet; this in itself is not a problem. The problem starts when moisture is trapped for any length of time. Therefore, it is very important to store the boat properly ashore.

Keep your dinghy drained and well ventilated

Ensure that the boat is stored with the bow raised to allow water to drain away.

Wash with fresh water

Fresh water evaporates far more quickly than salt water so if your dinghy has been sailed in salt water, rinse it thoroughly. The fittings will also work better if regularly washed. Any stubborn marks on the hull can be removed with a light detergent, such as washing up liquid. Always test cleaning products on a small, inconspicuous part of the deck before applying to the whole boat.

Hull damage falls into three categories:

- **SERIOUS** – large hole, split, crack, or worse. Don't be too distressed! Get the remnants back to RS Racing so we can assess the damage.
- **MEDIUM** – small hole or split. If this occurs during an event, sailing can often be continued as long as leaking can be prevented by drying the area and applying strong adhesive tape. CAUTION – if the damage is close to a heavily loaded point, then the surrounding area should be closely examined to ensure that it will accept the loads. Get the damage professionally repaired as soon as possible.
- **SMALL** – dents, scratching. This type of damage is not boat threatening.

Comptec PE3 cannot be repaired in the same way as fibre glass. Some scratching can be removed by RS Racing staff, but dents cannot. Therefore we suggest you treat your boat with as much care as you would if it were fibre glass. More serious repairs can be carried out by RS Racing staff; however, the repair will never be invisible, due to the nature of the material.

The joy of owning an RS Zest is that it is very hard wearing, and any dents and scratches it receives will not affect the structural integrity of the hull.



6.2 - Foil Care

The foils are FRP with a foam core. Look after them as you do the hull. Wash with fresh water regularly. Repair any chips as soon as possible.

If you intend to travel a lot with the boat, then an RS padded rudder bag would be a worthwhile investment.



6.3 - Spar Care

The mast and boom are aluminium. Wash with fresh water as often as possible, both inside and out. Check all of the riveted fittings on a regular basis for any signs of corrosion or wear.



6.4 - Sail Care

The mainsail and Jib should be rolled and stored dry, out of direct sunlight. When using a new sail for the first time, try to avoid extreme conditions as high loads on new sailcloth can diminish the racing life of the sail.

If your sail is stained in any way, try to remove it using a light detergent and warm water. DO NOT attempt to launder the sail yourself.

A sail can be temporarily repaired using a self-adhesive cloth tape, such as Dacron or Mylar. The sail should be returned to a sail maker for a professional repair. Check for wear and tear, especially around the batten pockets, on a regular basis.



6.5 - Mast Gate

After sailing the mast gate should be rinsed out with fresh water.

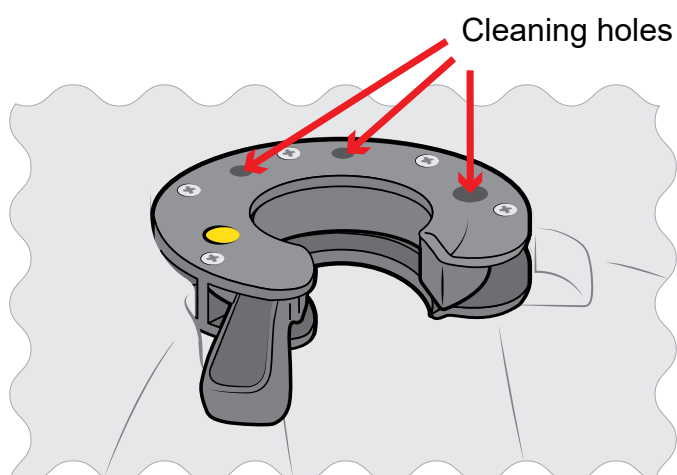

Knot #1



Knot #2



Knot #3



Knot #4



Knot #5



Knot #6



Knot #1 - Knot on knot

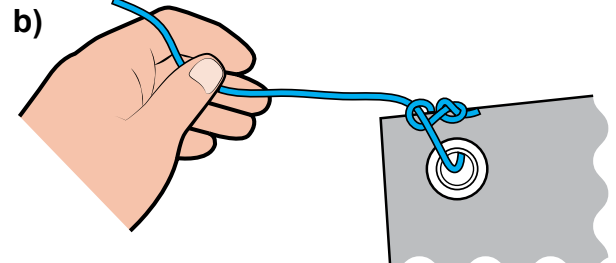
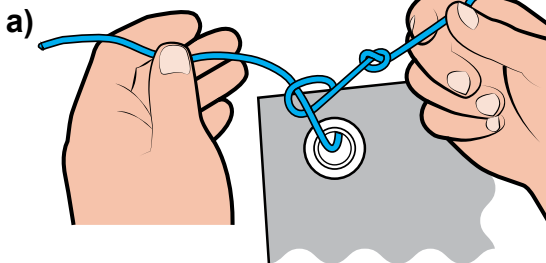

Knot #2 - Bowline

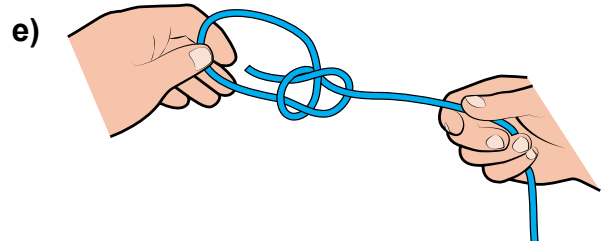
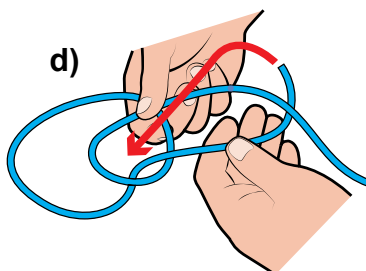
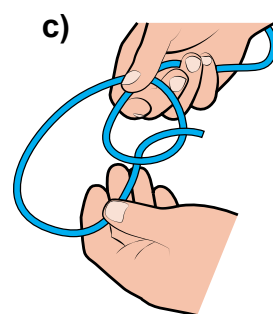
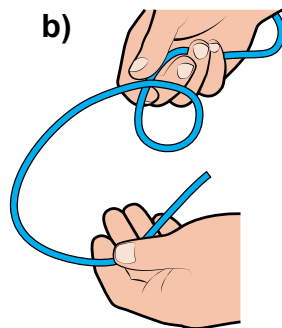
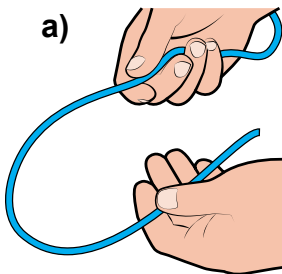

Knot #3 - Figure of eight

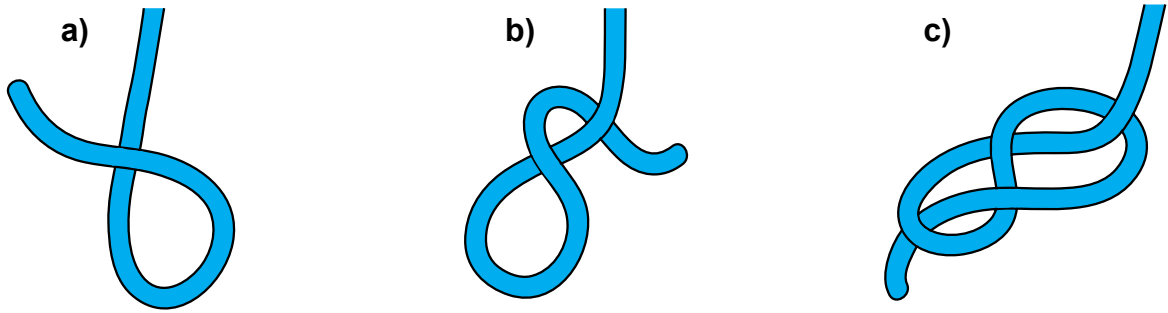

Knot #4 - Overhand knot

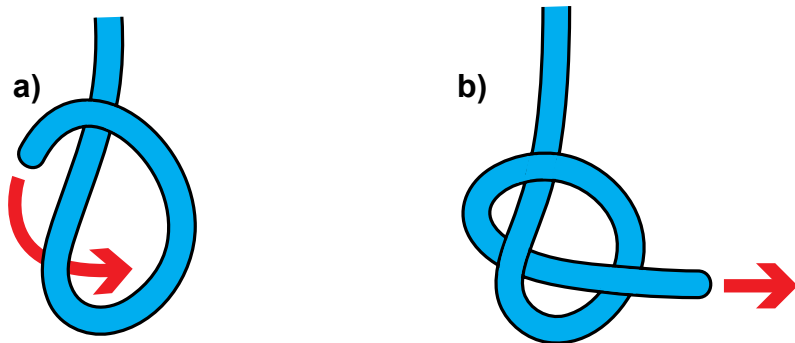

Knot #5 - Double sheet bend

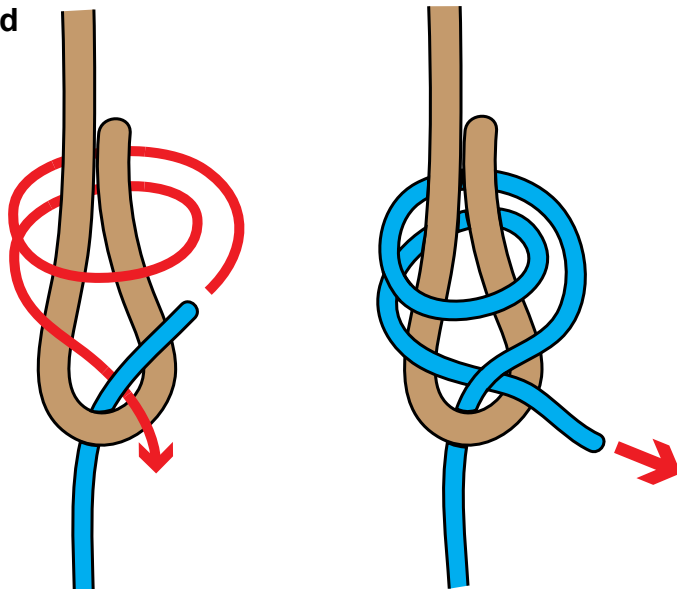

Knot #6 - Cow hitch

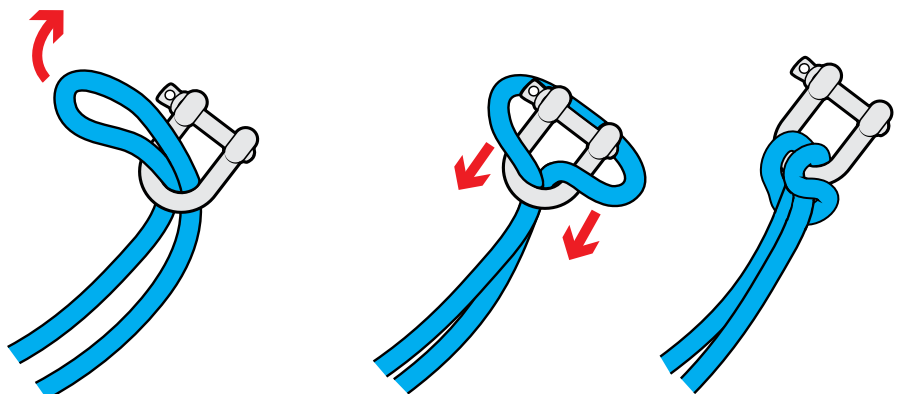

- 1.** This warranty is given in addition to all rights given by statute or otherwise.

- 2.** RS Sailing warrants all boats and component parts manufactured by it to be free from defects in materials and workmanship under normal use and circumstances, and the exercise of prudent seamanship, for a period of twelve (12) months from the date of commissioning by the original owner. The owner must exercise routine maintenance and care.

- 3.** This warranty does not apply to defects in surface coatings caused by weathering or normal use and wear.

- 4.** This warranty does not apply if the boat has been altered, modified, or repaired without prior written approval of RS Sailing. Any changes to the hull structure, deck structure, rig or foils without the written approval of RS Sailing will void this warranty.

- 5.** Warranty claims for materials or equipment not manufactured by RS Sailing can be made directly to the relevant manufacturer. RS Sailing warrants that these parts were installed correctly and according to the instructions provided by the manufacturer.

- 6.** Warranty claims shall be made to RS Sailing as soon as practicable and, in any event, within 28 days upon discovery of a defect. No repairs under warranty are to be undertaken without written approval of RS Sailing.

- 7.** Upon approval of a warranty claim, RS Sailing may, at its expense, repair or replace the component. In all cases, the replacement will be equal in value to the original component.

- 8.** Due to the continuing evolution of the marine market, RS Sailing reserves the right to change the design, material, or construction of its products without incurring any obligation to incorporate such changes in products already built or in use.

A

| | |
|-------------|---|
| Aft | At the back |
| Anchor Line | Rope that attaches the anchor to the boat |
| Astern | Behind the boat |
| Asymmetric | Gennaker flown from a retractable pole at the bow |

B

| | |
|--------------------|--|
| Back | To 'back the sail'; allowing the wind to fill the back of the sail |
| Bailer | A bucket or other container used for bailing water |
| Batten | A thin strip of wood/plastic inserted in the sail to keep it flat |
| Batten Key | A key used to adjust the batten |
| Batten Pocket | A pocket on the sail that holds the batten |
| Beam | Width of the boat at the widest point of the side of the boat. The phrase 'wind on the beam' means that the wind is coming from the side. |
| Bear away | To turn downwind |
| Beat | To sail a zig-zag course to make progress upwind |
| Beaufort Scale | A measure of wind strength, from Force 1 to Force 12 |
| Bilge Rail | The moulded line that marks the transition from the side to the bottom of the hull |
| Block | A pulley used for sail control lines |
| Boom | The spar at the bottom edge of sail |
| Boom Pad | The pad that fits onto the boom |
| Bow | The front of the boat |
| Bow Lifting Handle | The handle at the front of the boat, used for lifting |
| Bowline | A useful and reliable knot, with a loop in it |
| Bow Snubber | The part of the trolley that the bow rests on |
| Builder's Plate | Plate that contains build information |
| Bung | A stopper for the drain hole |

| | |
|----------------------|---|
| Buoy | Floating object attached to the bottom of sea – used variously for navigation, mooring, and to mark out a race course |
| Buoyancy Aid | Helps you to stay afloat if you fall in the water |
| Buoyancy Compartment | Water-tight compartment in the hull that maintains buoyancy |
| Burgee | Small flag at the top of the mast to show wind direction |

C

| | |
|-----------------------|---|
| Capsize | To overturn |
| Capsize Recovery | To right, or recover, the boat after a capsize |
| Catamaran | A boat with two hulls |
| Centreboard | The foil that sits below the hull to counteract the sideways push of the wind, and to create forward motion |
| Centreboard Case | The casing in the hull in which the centreboard sits |
| Centreline | An imaginary line that runs through the centre of the hull, from the bow to the stern |
| Chart datum | Depths shown on a chart, at the lowest possible tide |
| Cleat | A device to grip ropes and hold them in place – some grip automatically, while others need the rope tying around them |
| Clew | Lower corner of the sail, closest to the stern |
| Close hauled | Sailing as close to the wind as you can; point of sailing to sail upwind |
| Cockpit | The open area in the boat providing space for the helm and the crew |
| Collision Regulations | The 'rules of the road' to avoid collisions |
| Compass Rose | The compass shown on a chart to aid navigation |
| Crew | Helps the helmsman to sail the boat, and usually handles the jib sheets |
| Cutter | A boat with two headsails or jibs |

D

| | |
|---------------|---|
| Dacron | A brand of polyester sailcloth that is wrinkle-resistant and strong |
| Deck | A floor-like surface occupying part of the hull |
| Deck Moulding | A moulded deck |
| Downhaul | Applies downwards tension to a sail |
| Downwind | To sail in the direction that the wind is blowing |
| Drain Hole | A hole in the hull from which trapped water can be drained |

Draught The depth of the vessel below the surface

E

Ease To 'ease sheets' means to let the sail out gently

F

Fairlead A pulley block used to guide a rope to avoid chafing

Foils The daggerboard and the rudder

Foot The bottom edge of a sail

Fore Towards the front of the boat

Forestay The wire line that runs from the front of the mast to the bow of the hull, holding the mast in position

Furl To gather a sail into a compact roll and bind it against the mast or forestay

G

Gennaker A large sail that is hoisted when sailing downwind

Gennaker Chute Webbing pocket in which the gennaker is stowed when not hoisted

Gennaker Pole The sprit that protrudes from the front of the hull, to which the tack of the gennaker is attached

Gnav Bar Bar that sits between the mast and the boom, performing the same function as a kicking strap

Gnav Control Line Line that applies and releases tension to the gnav

Gooseneck The 'jaws' of the boom that clip onto the mast

Gunwhale The top edge of the hull, that you sit on when leaning out to balance the boat

Gybe To change tack by turning the stern of the boat through the wind.

H

Halyard The rope used to hoist sails

Halyard Bag Bag attached to the hull, in which the halyards can be stowed

Head The top corner of a sail

| | |
|----------------|---|
| 'Head to Wind' | To point the bow in the direction that the wind is blowing from, causing the sails to flap |
| 'Heave to' | To stop the boat by easing the main sheet and backing the jib |
| Heel | A boat 'heels' when it leans over due to the sideways force of the wind |
| Helm/Helmsman | The person who steers the boat, or another name for the tiller |
| Hoist Block | Block behind which the gennaker halyard is pulled when hoisting the gennaker |
| Hull | The hollow, lower-most part of the boat, floating partially submerged and supporting the rest of the boat |

I

| | |
|-----------------|--|
| 'Into the Wind' | To point the bow in the direction that the wind is blowing from, causing the sails to flap |
| Inversion | A capsize where the boat turns upside down, or 'turtles' |

J

| | |
|-----------|-------------------------------------|
| Jammer | Another word for a cleat |
| Jib | The small sail in front of the mast |
| Jib Sheet | The rope used to control the jib |

K

| | |
|---------------|--|
| Kicking strap | The rope system that is attached to the base of the mast and the boom, helping to hold the boom down |
| Knot | A measurement of speed, based on one minute of latitude |

L

| | |
|-----------|----------------------|
| Launching | To leave the slipway |
|-----------|----------------------|

| | |
|------------------------|---|
| Latitude | Imaginary lines running parallel round the globe from east to west. They help you measure position and distance on a chart. |
| Leech | The back edge of the sail |
| Leeward | The part of the boat furthest away from the direction in which the wind is blowing |
| Leeway | The amount of sideways drift caused by the wind |
| Leverage | The result of using crew weight as a 'lever' to counteract heel caused by the wind |
| Lie to | A way of stopping the boat temporarily by easing sheets on a close reach |
| Lifjacket | Unlike a buoyancy aid, a lifjacket will keep a person fully afloat with their head clear of the water |
| Longitude | Imaginary lines running round the globe from north to south, like segments of an orange. Used with lines of latitude to measure position and distance |
| Lower Furling Unit | The fitting at the bottom of the forestay that enables the jib to be furled |
| Luff | The front edge of the sail |
| M | |
| Mainsail | The largest sail on a boat |
| Mainsail Clew Slug | The fitting that sits in the track on the boom, to which the clew of the mainsail is attached |
| Mainsheet | The rope used to control the mainsail |
| Mainsheet Bridle | The rope runs across the transom of the boat, to which the mainsheet is attached |
| Mainsheet Centre Block | The main block, usually fixed to the cockpit floor, through which the mainsheet passes |
| Man Overboard Recovery | The act of recovering a 'man overboard' from the water |
| Mast | The spar that the sails are hoisted up |
| Mast Foot | The bottom of the mast |
| Mast Gate | Fitting which closes across the front of the mast at deck level, holding the mast in place |

| | |
|--------------------|---|
| Mast Lower Section | The bottom section of a two-piece mast |
| Mast Step | The fitting on the deck that the mast fits into |
| Mast Top Section | The top section of a two-piece mast |
| Meteorology | The study of weather forecasting |
| Moor | To tie the boat to a fixed object |
| Mylar | A brand of strong, thin, polyester film used to make racing sails |

N

| | |
|-----------------------------|--|
| National Sailing Federation | Body that governs sailing in a nation. In the UK, this is the Royal Yachting Association |
| Navigation | To find a way from one point to the other |
| Neap Tide | Tides with the smallest tidal change |

O

| | |
|----------------------|--|
| 'Off the Wind' | To sail in the direction that the wind is blowing |
| Outboard Bracket Kit | Bracket which enables an outboard engine to be attached to the transom |
| Outboard Engine | Small portable engine that attaches to the transom |
| Outhaul | The control line that applies tension to the foot of the sail, by pulling the sail along the boom |
| Outhaul Hook | The fitting on the boom that hooks the eye at the back of the sail, and to which the outhaul is attached |

P

| | |
|---------|--|
| Painter | The rope at the bow used to tie the boat to a fixed object |
| Pontoon | A floating jetty to moor your boat to |
| Port | The left-hand side of the boat, when facing forwards |

R

| | |
|-----------|---|
| RS Dealer | A third-party who sells the RS range |
| Reach | Sailing with the wind on the side of the boat |

| | |
|-----------------|--|
| Reef | To make the sails smaller in strong winds |
| Retaining Pin | On a trolley, to hold the launching trolley to the road base |
| Road Base | A trolley that you place your boat and launching trolley upon to trail behind a vehicle |
| Rowlocks | U shaped fittings that fix onto the gunwale and holds your oars in position while rowing |
| Rowlock Holes | The holes in the gunwhale into which the rowlocks fit |
| Rudder | The foil that, when attached to the stern, controls the direction of the boat |
| Rudder Blade | The large, rigid, thin part of the rudder |
| Rudder Downhaul | The control line that enables you to pull the rudder into place |
| Rudder Pintle | The fitting on the transom onto which the rudder stock fits |
| Rudder Stock | The top part of the rudder, usually including the tiller, into which the rudder blade fits, and which then attaches to the rudder pintle |
| Run | To 'run with the wind', or to sail in the direction that the wind is blowing |

S

| | |
|----------------------------|--|
| Safety-Boat Cover | Support boats, usually RIBs, in case of emergency |
| Sail | An area of material attached to the boat that uses the wind to create forward motion |
| Sailmaker | A manufacturer of sails |
| Sail Number | The unique number allocated to a boat, displayed on the sail when racing |
| Sail Pressure | A sail has 'pressure' when it is working with the wind to create motion |
| Sailing Regatta | An event that usually comprises of a number of sailing races |
| Shackle | A metal fitting for attaching ropes to blocks, etc. |
| Shackle Key | Small key used to undo tight shackles |
| Sheet | A rope that controls a sail |
| Shroud | The wires that are attached to the mast and the hull, holding the mast up |
| Side Safety Line | The line that runs along the side of the hull |
| Single Handed | To sail a boat alone |
| Single-Line Reefing System | An efficient method of reefing with one line |

| | |
|-----------------------|---|
| Slider | Sliding fitting on the boom to which the gnav bar is attached |
| Soundings | The numbers on a chart showing depth |
| Spars | The poles, usually carbon or aluminium, to which the sail is attached |
| Spreaders | Metal fittings attached to the mast which hold the shrouds out |
| Spring Tide | The tides with the biggest range and strongest currents |
| Starboard. | The right-hand side of the boat, when facing forwards |
| Stern | The back of the boat |
| Stern Lifting Handles | The handles at the stern, used for lifting the boat |
| Stopper Knot | A form of knot used to prevent a rope from sliding through a fitting, such as a pulley or a cleat |

T

| | |
|------------------|--|
| Tack | a) To change direction by turning the bow of the boat through the wind b) The bottom front corner of a sail |
| Tack Bar | The bar at the bow of the hull, to which the tack of the jib is attached |
| Tack Line | The rope that emerges from the front of the gennaker pole, to which the tack of the gennaker is attached |
| Tender | A small vessel, usually used to transport crew to a larger vessel |
| Tidal height | The depth of water above chart datum |
| Tidal range | The difference between the depth of water at low and high tide |
| Tidal stream | The direction in which the tide is flowing |
| Tiller | The stick attached to the rudder, used to steer the boat |
| Tiller Extension | A pole attached to the tiller to extend its reach, usually used when hiking |
| Toe Straps | The straps to tuck your feet under when you lean out to balance the boat. |
| Top Furling Unit | Fitting at the top of the forestay which enables the jib to be furled |
| Towing Line | A rope attached to the boat, used to connect to a towing vessel |
| Transit | An imaginary line between two fixed objects, used to ensure that you are staying on course |
| Transom | The vertical surface at the back of the boat |
| Trim | Keeping the boat level fore and aft |
| Trimaran | A boat with three hulls |
| Trolley | A wheeled structure, used to move the boat around on land |
| Trolley Supports | The part of the trolley in direct contact with the hull |

U

'Under Weigh' A term derived from the act of 'weighing' anchor, meaning to be in motion

Upwind To sail against the direction in which the wind is blowing

W

Wetsuit Neoprene sailing suit designed to keep you warm when wet

Windward The part of the boat closest to the direction in which the wind is blowing